

# CONVEYOR OVERVIEW

**DORNER**<sup>®</sup>  
MOVE FAST. MOVE SMART.

*AquaGard*<sup>®</sup>

*AquaPruf*<sup>®</sup>

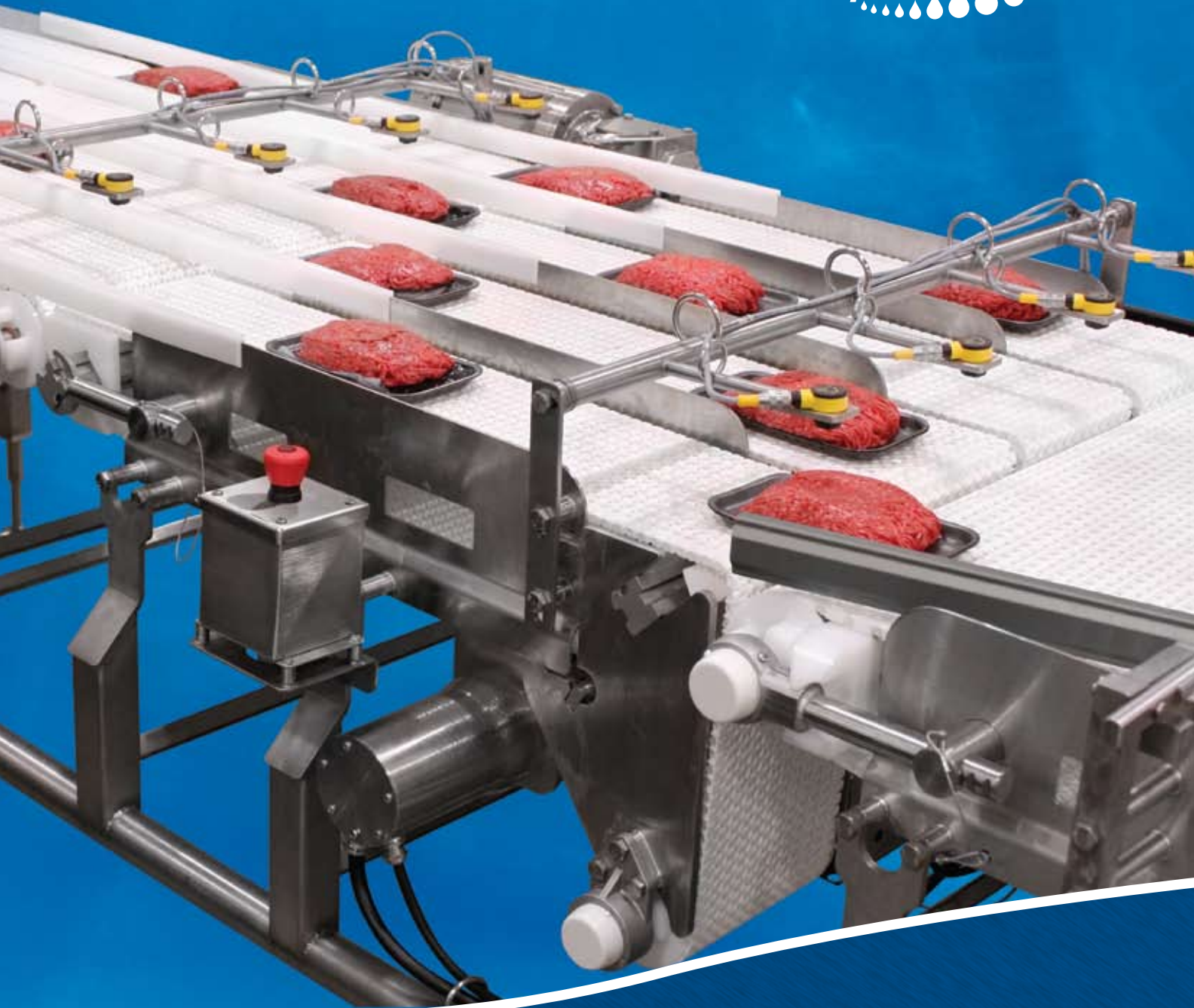

From packaging to processing, Dorner has the food industry covered. By offering three series of sanitary conveyors – *AquaGard*<sup>®</sup>, *AquaPruf*<sup>®</sup> and *AquaPruf*<sup>®</sup> *Ultimate* – Dorner can meet virtually any need.

To identify the series best for you, simply locate your market and application in one of the four charts below. You can then utilize the chart stretching along the bottom of the page to select your specific conveyor model.



<b>MARKET</b>	<b>BAKERY • SNACK FOODS • CONFECTIONARY</b>		
<b>APPLICATION</b>	<b>PACKAGED</b>	<b>COOKED</b>	<b>RAW</b>
<b>RECOMMENDED PLATFORM</b>	<i>AquaGard</i> <sup>®</sup>		



<b>MARKET</b>	<b>FRUITS • VEGETABLES • NON-PROTEIN READY-TO-EAT</b>		
<b>APPLICATION</b>	<b>PACKAGED</b>	<b>COOKED</b>	<b>RAW</b>
<b>RECOMMENDED PLATFORM</b>	<i>AquaGard</i> <sup>®</sup>		<i>AquaPruf</i> <sup>®</sup>



	Cleaning Method			Type of Cleaning Agent				Environment		
	Wipe Down	Wash Down		Water	Soap/Water	Diluted Bleach or Alcohol	Foaming Caustic	Dry	Wet	
		Low Pressure	High Pressure							
<i>AquaGard</i> <sup>®</sup>	7350	•	•		•	•	•		•	•
	7360	•	•		•	•	•		•	•
<i>AquaPruf</i> <sup>®</sup>	7400	•	•	•	•	•	•	•	•	•
	7600	•	•	•	•	•	•	•	•	•
<i>AquaPruf</i> <sup>®</sup> <b>ULTIMATE</b>	7400U	•	•	•	•	•	•	•	•	•
	7600U	•	•	•	•	•	•	•	•	•





<b>MARKET</b>	<b>PROTEINS • DAIRY • READY-TO-EAT W/PROTEIN</b>		
<b>APPLICATION</b>	<b>PACKAGED</b>	<b>COOKED</b>	<b>RAW</b>
<b>RECOMMENDED PLATFORM</b>	AquaPruf®		AquaPruf® Ultimate

<b>MARKET</b>	<b>MEDICAL • PERSONAL CARE • PHARMACEUTICAL</b>		
<b>APPLICATION</b>	<b>PACKAGED</b>	<b>PROCESSED</b>	<b>RAW MATERIALS</b>
<b>RECOMMENDED PLATFORM</b>	AquaGard®		AquaPruf®

Sanitary Features							Belt Type	Frame Construction	Offering
Belt Lifters	Clean Out Windows	Tip Up Tail	Complete Tool-less Disassembly	Approvals					
				FDA	Bissc	USDA Red Meat & Poultry			
				•	•		Modular Plastic	TIG Welded Stainless Steel	Straight/ Curve/Z-Frame
		•		•	•		Belt	TIG Welded Stainless Steel	Straight/Z-Frame
•	•	•		•	•		Modular Plastic	Continuous TIG Welded Stainless Steel	Straight/ Curve/Z-Frame
•	•	•		•	•		Belt	Continuous TIG Welded Stainless Steel	Straight/ Z-Frame
•	•	•	•	•		•	Modular Plastic	Continuous TIG Welded Stainless Steel	Straight/ Curve/Z-Frame
•	•	•	•	•		•	Positive Belt Driven	Continuous TIG Welded Stainless Steel	Straight/ Z-Frame

# THE DORNER<sup>®</sup> ADVANTAGE

A program of action, support and service that make the customer's choice **Smart** and **Fast**

## Application Hotline: 800-351-8712

A direct line to our engineers, where customers can call to discuss applications and options.



## Industry leading 10 year limited warranty

The longest warranty being offered in the conveyor industry, this reduces the total cost of ownership.



## Shortest lead time in the conveyor industry

No other company can deliver custom sized and application ready conveyors faster than Dorner.

CONVEYOR TYPE	LEAD TIME (IN DAYS TO SHIP)*
<b>ALUMINUM EXTRUSION</b>	
V-Guided Belt	<b>3</b>
Modular Belt	<b>5</b>
<b>STAINLESS STEEL</b>	
V-Guided Belt	<b>10</b>
Modular Belt	<b>10</b>

\* Applies to products configured in E-Pricer.





**Service Hotline:  
888-417-3515**

An after hours hotline, where customers can call and get help troubleshooting conveyors from a member of Dorner's FIT team of service experts. Dorner's Service never sleeps.

# DORNER FIT PROGRAM

FACTORY INSPECTION & TRAINING



## Get FIT and Stay FIT Visits

A support program to ensure equipment is installed correctly, and that existing equipment is maintained for optimal performance.



## FIT Replacement Parts

Original equipment, wear and maintenance parts from Dorner, that will add conveyor life, maximize production time and ensure the customer's warranty is maintained.



## FIT Training

A custom designed training course for the customer's engineers and maintenance personnel that ensures proper conveyor maintenance and safety that optimizes conveyor performance.



## Specifications:

- Flat and Cleated Belt models
- Loads up to 60 lbs\* (27 kg)
- Belt speeds up to 264 ft/min (81 m/min)
- Belt widths: 1.75" (44 mm) to 18" (457 mm)
- Conveyor lengths: 2' (610 mm) to 18' (8,486 mm)
- Cleats available from 0.43" (1 mm) to 2.36" (60 mm) high
- 11 gauge stainless steel roll formed frame
- Complete stainless steel construction
- 1.25" (32 mm) diameter drive pulley turns approximately 4.25" (108 mm) of belt per revolution
- 1.5" (38 mm) bottom of frame to top of belt
- Self-aligning stainless steel sealed bearings with FDA approved solid lubricant
- Washdown rated gearmotors and controls
- CE models available



\* Conveyor load capacity depends on conveyor size, incline, motor position, accumulated loads and other factors.

## Features & Benefits:

- Quick five-minute belt change for increased uptime
- Rack and pinion for fast single point belt tensioning
- 304 stainless steel frame, head and tail plates are polished to a #4 finish
- V-Groove frame with guided belt ensures accurate tracking
- Wedge-Lok™ system for impact protection
- Streamlined design fits where other conveyors do not
- Low profile, single piece frame for quick, easy cleaning
- Quick-clamp rail for easy mounting of bolt-on accessories
- Optional 0.25" (6 mm) thick bottom wiper for Flat Belt End Drives
- A variety of FDA approved belting to meet application needs



Soap & Water Cleaners



Chlorinated Cleaners



## AQUAGARD® 7200 & 7300 SERIES

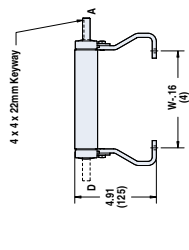

**7200**

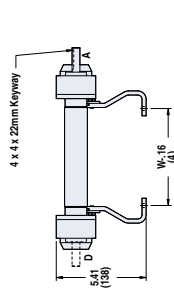
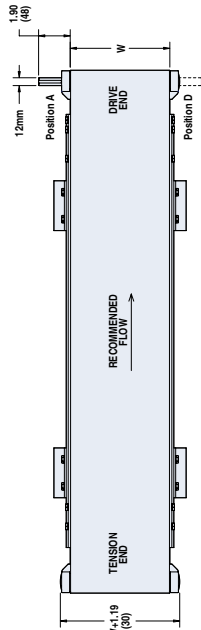

**7300**

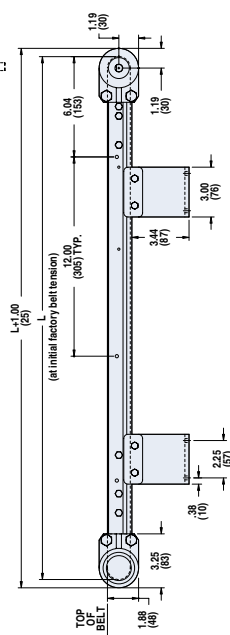
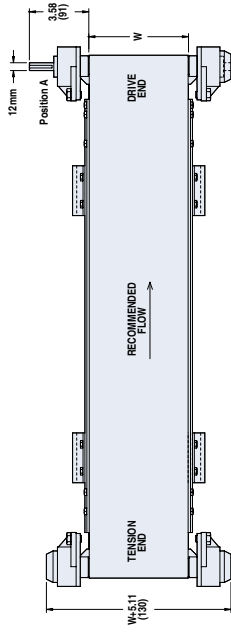

W = Conveyor Belt Width Dim = in (mm)

### STANDARD MODELS



**Flat Belt End Drive**



**Cleated Belt End Drive**

### STANDARD OPTIONS

#### Optional Bottom Wiper

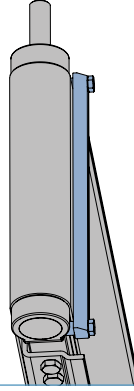

#### Optional Tool-less Belt Change Handles for Quick Belt Release

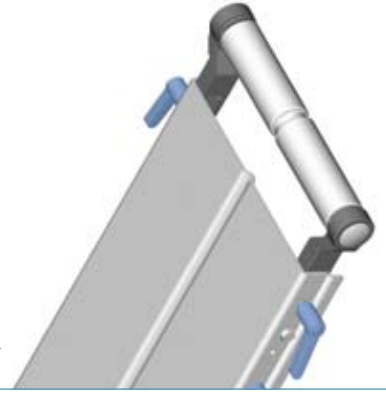

For more information, go to [www.dorner.com](http://www.dorner.com). Call 800.397.8664 or 262.367.7600.  
Due to the wide variety of drive set ups and applications, point of installation guarding is the responsibility of the end user.



**Improve your bottom line results with industry leading speeds, best in class product transfers, and ease of automation.**

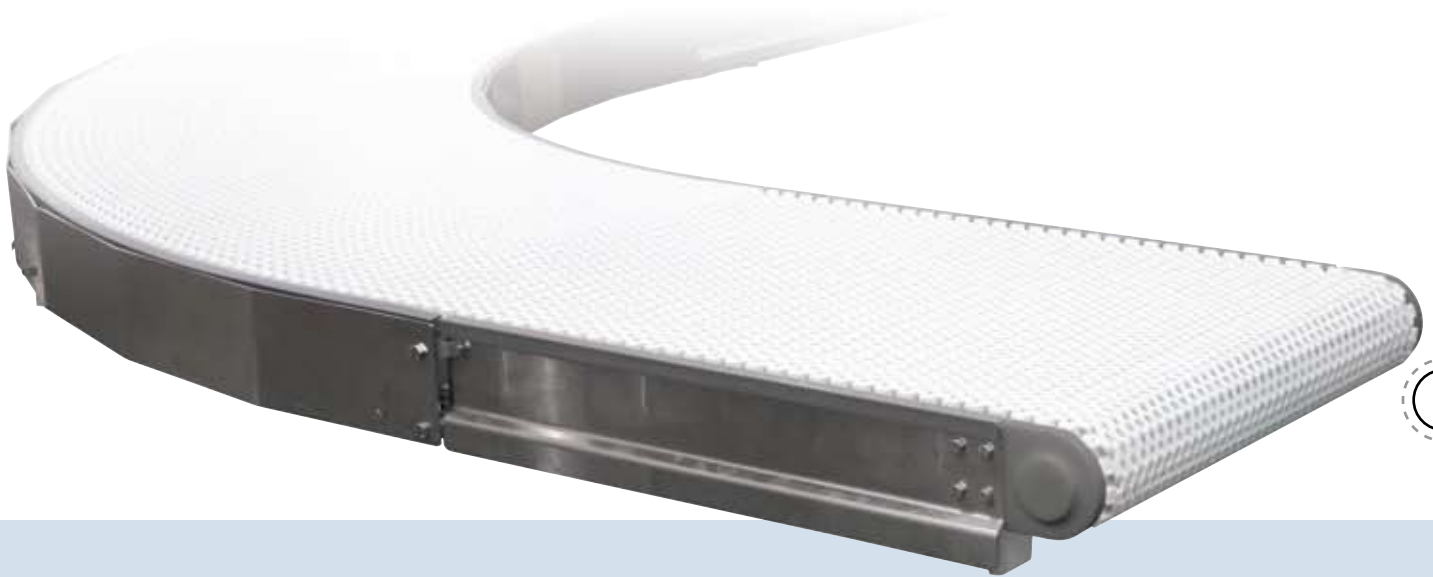

## Tailor Fit Accessories for Your Needs

Ease of Automation & Guiding

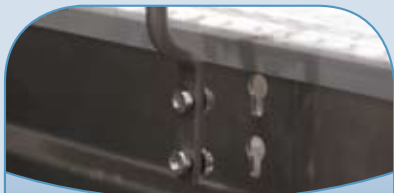

**No Drilling with Innovative Key Hole & Mounting Rod**



**Low Voltage Wiring Accessories**



**Accessory Bar for Mounting Multiple Accessories**



**Fully Adjustable Single Rail**



**Fully Adjustable Twin Rail**



**High Side Guide**



## Maximum Flexibility

- Straights, Curve and Z-Frame Modules
- 3 Product Transfers to Choose From
- No Drilling Required for Ease of Automation or Guiding
  - Attach controls, photo eyes, low voltage wire, & air tubing
  - Attach accessory bar for mounting several automation components
  - Attach any of standard guide packages to tailor fit conveyor

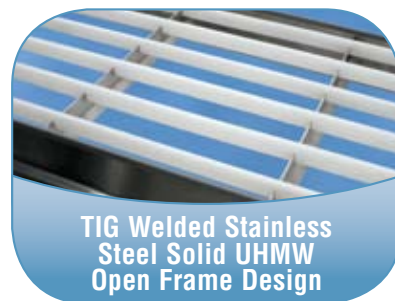

## Increase Throughput

- Speeds up to 260 feet per minute
- Available in Straights, Curves and Z-Frames
- 1" Nose Bar Tails
- Powered Transfer



## Reduce Product Loss

- 1" Nose Bar Tails for small part transfer
- Powered Transfer for maintaining speeds through transfer
- Roller transfer plate for smooth product transfer in minimal added length

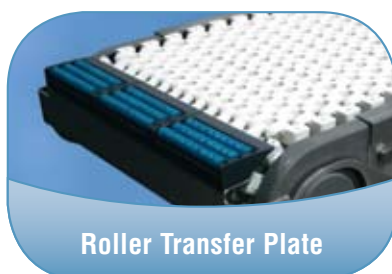



## Specifications:

- Modular Flat, Modular Cleated and Curved Modular Flat Belt models
- Loads up to 750 lbs\* (453 kg)
- Belt speeds up to 260 ft/min (78.6 m/min)
- Belt widths: 4" (102 mm) to 36" (914 mm)
- Conveyor lengths: 3' (914 mm) to 83' (25,298 mm)
- Cleats available in 1" and 3" heights
- 45°, 90°, 135°, & 180° curves available
- Wearstrip material is UHMW
- TIG welded 304 Stainless Steel Frame
- FDA approved belting and plastic components
- **CE** models available

\* Conveyor load capacity depends on conveyor size, incline, motor position, accumulated loads and other factors.



## Features & Benefits:

- Frame is constructed of TIG welded 304 stainless steel and features open design with minimal horizontal surfaces
- Solid UHMW wear strips located in welded cross members for durable belt support
- Mount controls and accessories fast with no drilling required includes adjustable guiding, photo eyes, low voltage wires, controls, and air tubing
- Flexible guiding packages for a variety of applications including fully adjustable single and twin rail, and high side
- The nose bar drive and idler tails (optional) has 1" diameter pulley available for small product transfers
- The Powered Transfer (optional) has 1/2" diameter pulleys for maintaining speed through transfer
- Roller Transfer Plate (optional) for smooth product transfer in minimal added length
- Conveyor is suitable for wipe-down and occasional pressurized liquid spray cleaning up to 100 psi max



Easy to  
Accessorize

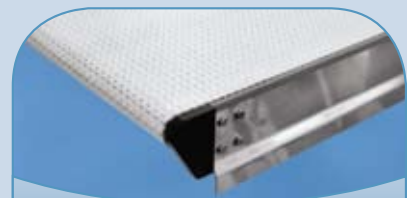

1" Nose Bar  
Tail



## AQUAGARD® 7350 SERIES: STRAIGHT & CURVED MODULAR BELT

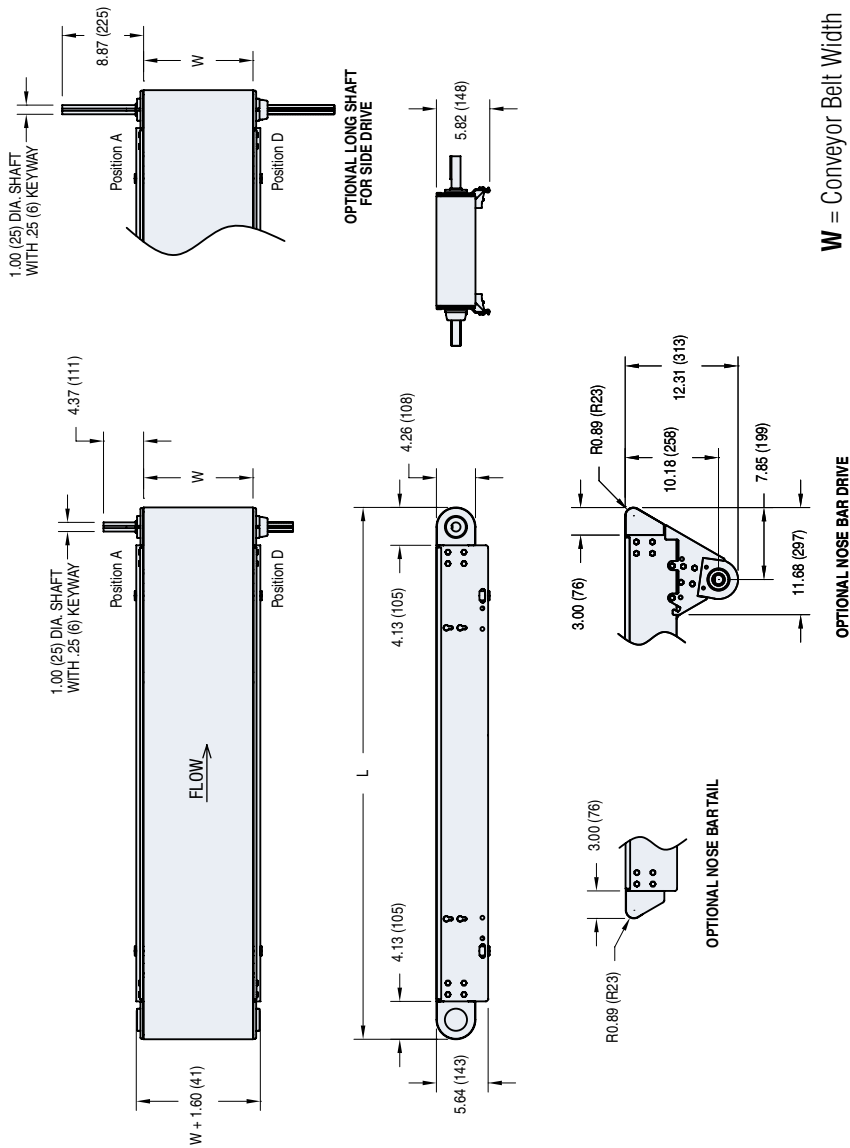

### STANDARD OPTIONS

#### Powered Transfer

For small parts and maintaining speeds through transfer. Slave driven with speeds up to 260 ft/min.



#### Roller Transfer Plate

For smooth product transitions in minimal added length.



### STANDARD MODELS



Modular Flat Belt

Modular Cleated Belt

Curved Modular Flat Belt

For more information, go to [www.dorner.com](http://www.dorner.com). Call 800.397.8664 or 262.367.7600.

Due to the wide variety of drive set ups and applications, point of installation guarding is the responsibility of the end user.

## Specifications:

- Z-Frame Modular Flat, Modular Cleated and Curved Modular Flat Belt models
- Loads up to 750 lbs (453 kg)
- Belt speeds up to 260 ft/min maximum (78.6 m/min)
- Belt widths: 4" (102 mm) to 24" (610 mm)
- Total lengths up to 83' (25,298 mm)
- Z-Frame Straight and Z-Frame Curved Modular Flat Belt has 5° to 30° fixed angle modules available in 5° increments
- Z-Frame Modular Cleated Belt has 5° to 60° fixed angle modules available in 5° increments
- 45°, 90°, 135°, & 180° curves available
- Wearstrip material is UHMW
- TIG welded 304 Stainless Steel Frame
- FDA approved belting and plastic components
- **CE** models available

\* Conveyor load capacity depends on conveyor size, incline, motor position, accumulated loads and other factors.



## Features & Benefits:

- Frame is constructed of TIG welded 304 stainless steel and features open design with minimal horizontal surfaces
- Solid UHMW wear strips located in welded cross members for durable belt support
- Mount controls and accessories fast with no drilling required includes adjustable guiding, photo eyes, low voltage wires, controls, and air tubing
- Flexible guiding packages for a variety of applications including fully adjustable single and twin rail, and high side
- The nose bar drive and idler tails (optional) has 1" diameter pulley available for small product transfers
- The Powered Transfer (optional) has 1/2" diameter pulleys for maintaining speed through transfer
- Roller Transfer Plate (optional) for smooth product transfer in minimal added length
- Conveyor is suitable for wipe-down and occasional pressurized liquid spray cleaning up to 100 psi max



Easy to  
Accessorize

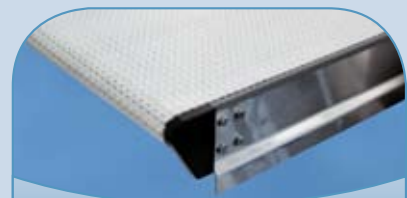

1" Nose Bar  
Tail



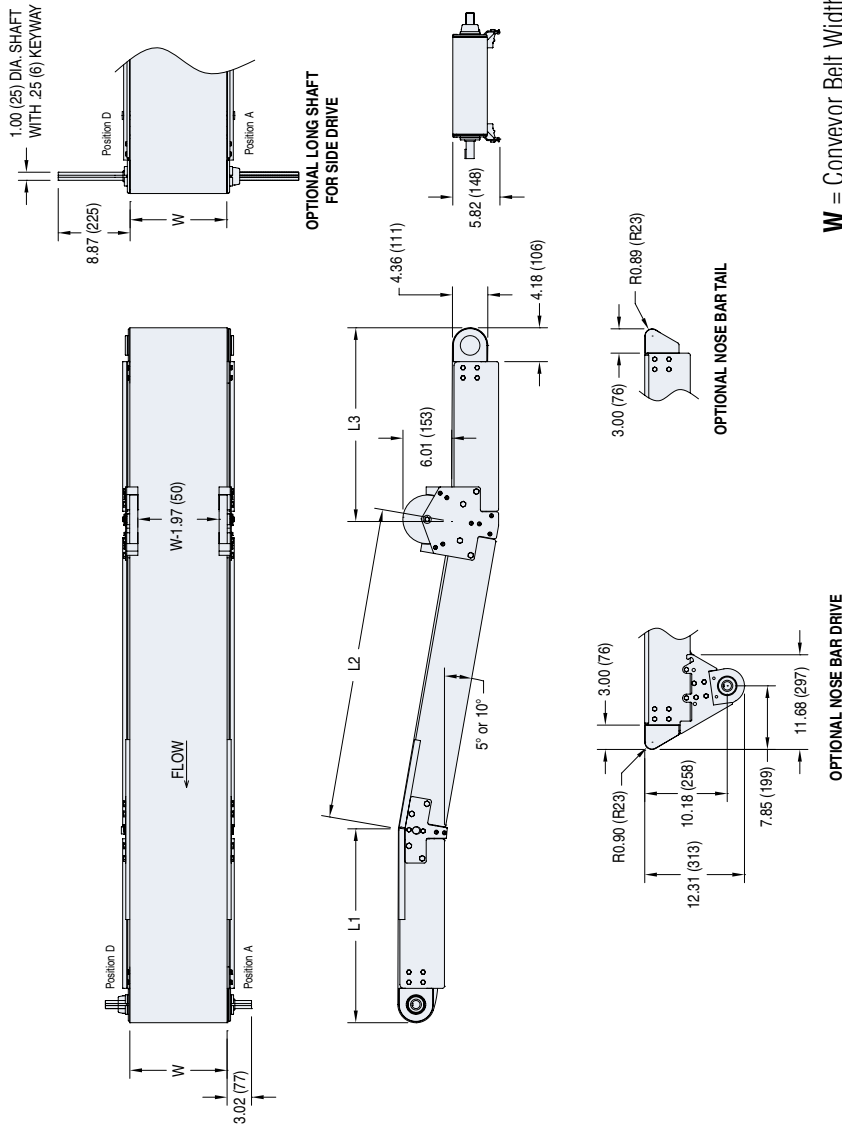

W = Conveyor Belt Width    Dim = in (mm)

**STANDARD OPTIONS**

**Powered Transfer**

For small parts and maintaining speeds through transfer. Slave driven with speeds up to 260 ft/min.



**Roller Transfer Plate**

For smooth product transitions in minimal added length.



**STANDARD MODELS**

**Z-Frame Modular Flat Belt**

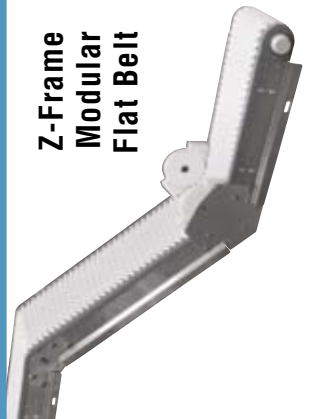

**Z-Frame Modular Cleated Belt**



**Z-Frame Curved Modular Flat Belt**



For more information, go to [www.dorner.com](http://www.dorner.com). Call 800.397.8664 or 262.367.7600.

Due to the wide variety of drive set ups and applications, point of installation guarding is the responsibility of the end user.



**Improve your bottom line results with industry leading speeds, best in class product transfers, and ease of automation.**



## Tailor Fit Accessories for Your Needs

Ease of Automation & Guiding



**No Drilling with Innovative Key Hole & Mounting Rod**



**Low Voltage Wiring Accessories**



**Accessory Bar for Mounting Multiple Accessories**



**Fully Adjustable Single Rail**



**Fully Adjustable Twin Rail**



**High Side Guide**



## Maximum Flexibility

- Straights & Z-Frame Modules
- 3 Product Transfers to Choose From
- No Drilling Required for Ease of Automation or Guiding
  - Attach controls, photo eyes, low voltage wire, & air tubing
  - Attach accessory bar for mounting several automation components
  - Attach any of standard guide packages to tailor fit conveyor



## Increase Throughput

- Speeds up to 300 feet per minute
- V-Guided Belt Tracking
- 1" Nose Bar Tails
- Powered Transfer

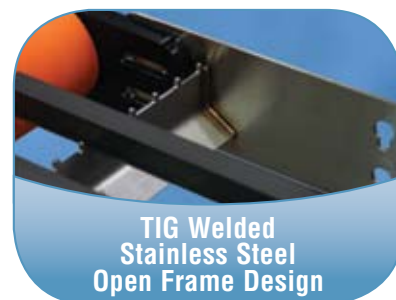

## Reduce Product Loss

- 1" Nose Bar Tails for small part transfer
- Powered Transfer for maintaining speeds through transfer
- Roller transfer plate for smooth product transfer in minimal added length

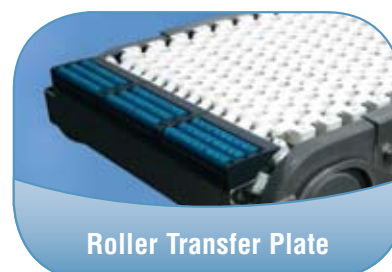



## Specifications:

- Flat and Cleated Belt models
- Loads up to 500 lbs (453 kg)
- Belt speeds up to 300 ft/min maximum (91 m/min)
- Belt widths: 4" (102 mm) to 52" (1,321 mm)
- Total lengths: 3' (914 mm) up to 40' (12,192 mm)
- Cleats available in 1" and 3" heights
- Wearstrip material is hard coat anodized aluminum
- TIG welded 304 Stainless Steel Frame
- FDA approved belting and plastic components
- CE models available



\* Conveyor load capacity depends on conveyor size, incline, motor position, accumulated loads and other factors.

## Features & Benefits:

- Frame is constructed of TIG welded 304 stainless steel and features open design with minimal horizontal surfaces
- Hard coat anodized aluminum wear strips located in welded cross members for durable belt support
- Mount controls and accessories fast with no drilling required includes adjustable guiding, photo eyes, low voltage wires, controls, and air tubing
- Flexible guiding packages for a variety of applications including fully adjustable single and twin rail, and high side
- Spindle has groove for V-guided belt and optimum performance
- Integrate jack-screw system in tails for belt take up and easy tracking adjustments
- The center drive (optional) allows additional clearance on ends when needed
- The nose bar drive and idler tails (optional) has 1" diameter pulley available for small product transfers
- The Powered Transfer (optional) has 1/2" diameter pulleys for maintaining speed through transfer
- Roller Transfer Plate (optional) for smooth product transfer in minimal added length
- Conveyor is suitable for wipe-down and occasional pressurized liquid spray cleaning up to 100 psi max



Easy to  
Accessorize



1" Nose Bar  
Tail



OPTIONAL LONG SHAFT FOR SIDE DRIVE

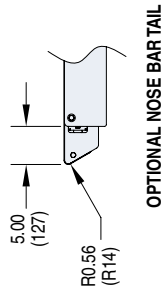
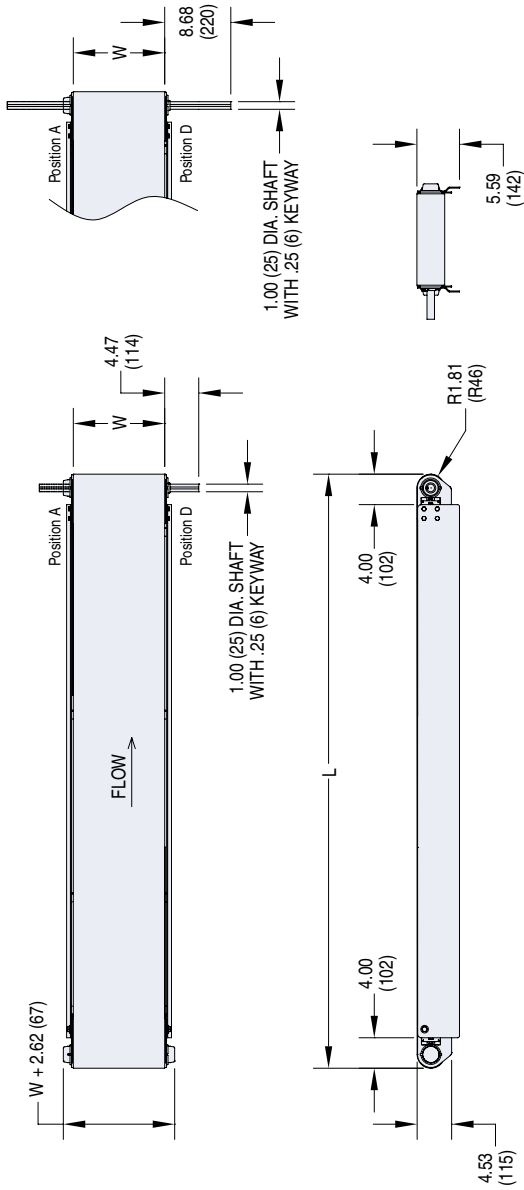

OPTIONAL NOSE BAR TAIL

W = Conveyor Belt Width Dim = in (mm)

**STANDARD MODELS**



**Flat Belt**



**Cleated Belt**

**CENTER DRIVE MODULE**



**STANDARD OPTIONS**

**Powered Transfer**

For small parts and maintaining speeds through transfer. Slave driven with speeds up to 260 ft/min.



**Roller Transfer Plate**

For smooth product transitions in minimal added length.

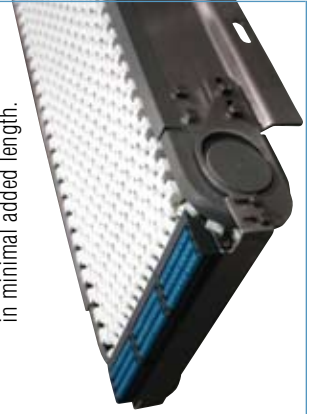



## Specifications:

- Z-Frame Flat and Cleated Belt models
- Loads up to 500 lbs (453 kg)
- Belt speeds up to 300 ft/min maximum (91 m/min)
- Belt widths: 4" (102 mm) to 24" (610 mm)
- Total lengths up to 40' (12,192 mm)
- Modular Flat has 5° to 30° fixed angle modules
- Modular Cleated has 5° to 60° fixed angle modules available in 5° increments
- Wearstrip material is hard coat anodized aluminum
- TIG welded 304 Stainless Steel Frame
- FDA approved belting and plastic components
- CE models available



\* Conveyor load capacity depends on conveyor size, incline, motor position, accumulated loads and other factors.

## Features & Benefits:

- Frame is constructed of TIG welded 304 stainless steel and features open design with minimal horizontal surfaces
- Hard coat anodized aluminum wear strips located in welded cross members for durable belt support
- Mount controls and accessories fast with no drilling required includes adjustable guiding, photo eyes, low voltage wires, controls, and air tubing
- Flexible guiding packages for a variety of applications including fully adjustable single and twin rail, and high side
- Spindle has groove for V-guided belt and optimum performance
- Integrate jack-screw system in tails for belt take up and easy tracking adjustments
- The center drive (optional) allows additional clearance on ends when needed
- The nose bar drive and idler tails (optional) has 1" diameter pulley available for small product transfers
- The Powered Transfer (optional) has 1/2" diameter pulleys for maintaining speed through transfer
- Roller Transfer Plate (optional) for smooth product transfer in minimal added length
- Conveyor is suitable for wipe-down and occasional pressurized liquid spray cleaning up to 100 psi max



Easy to  
Accessorize



1" Nose Bar  
Tail

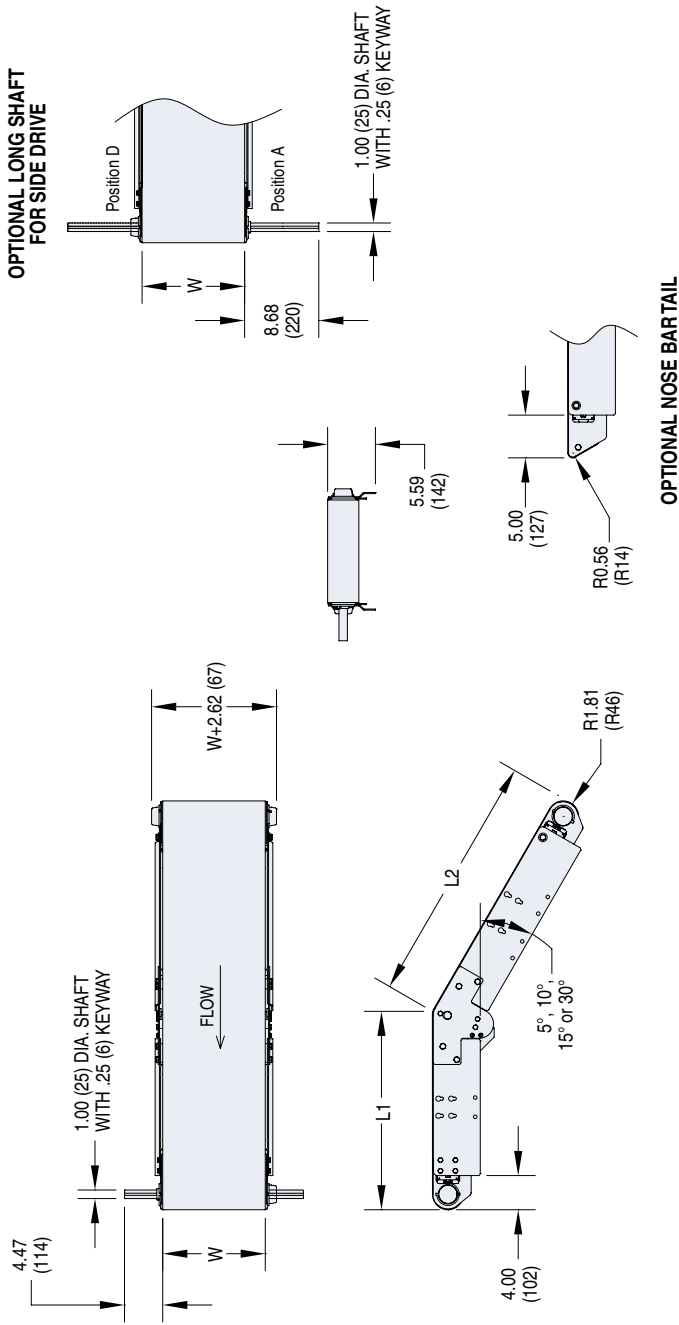

W = Conveyor Belt Width    Dim = in (mm)

**STANDARD MODELS**

**Z-Frame Flat Belt**

**Z-Frame Cleated Belt**

**CENTER DRIVE MODULE**

**STANDARD OPTIONS**

**Powered Transfer**

For small parts and maintaining speeds through transfer. Slave driven with speeds up to 260 ft/min.



**Roller Transfer Plate**

For smooth product transitions in minimal added length.



# Designed to transport Food & Pharmaceutical product with confidence while keeping operators safe.



Eliminates sprocket fasteners and keeps pulleys safe & sanitary.

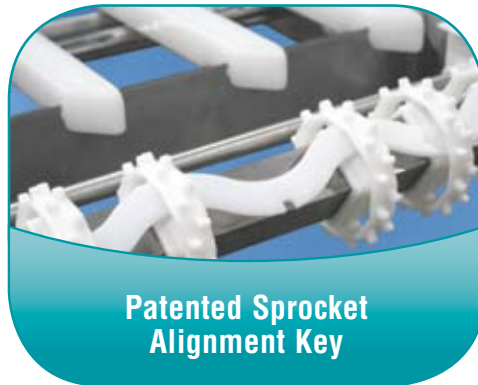

Provides continuous sprocket alignment for quick belt assembly.



For easy cleaning on wide or long conveyors.



For quick release of belt tension.





Eliminate horizontal surfaces for complete drainage.



Quickly removed without tools for cleaning. Most pieces are identical & completely interchangeable.



**Stainless Steel Gearmotors**  
located outside food zone.

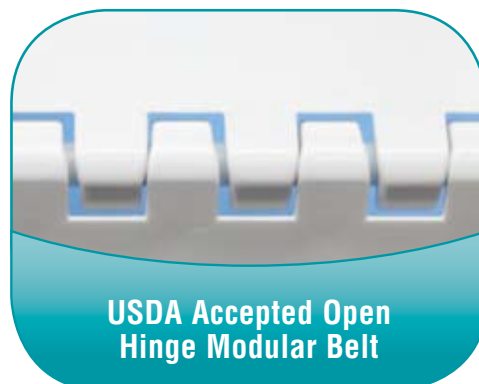

Improves cleaning and access to pins.



Eliminates fasteners in food zone.  
(Continuous TIG welding)



## Fast & Effective Sanitation Options for Daily Cleaning

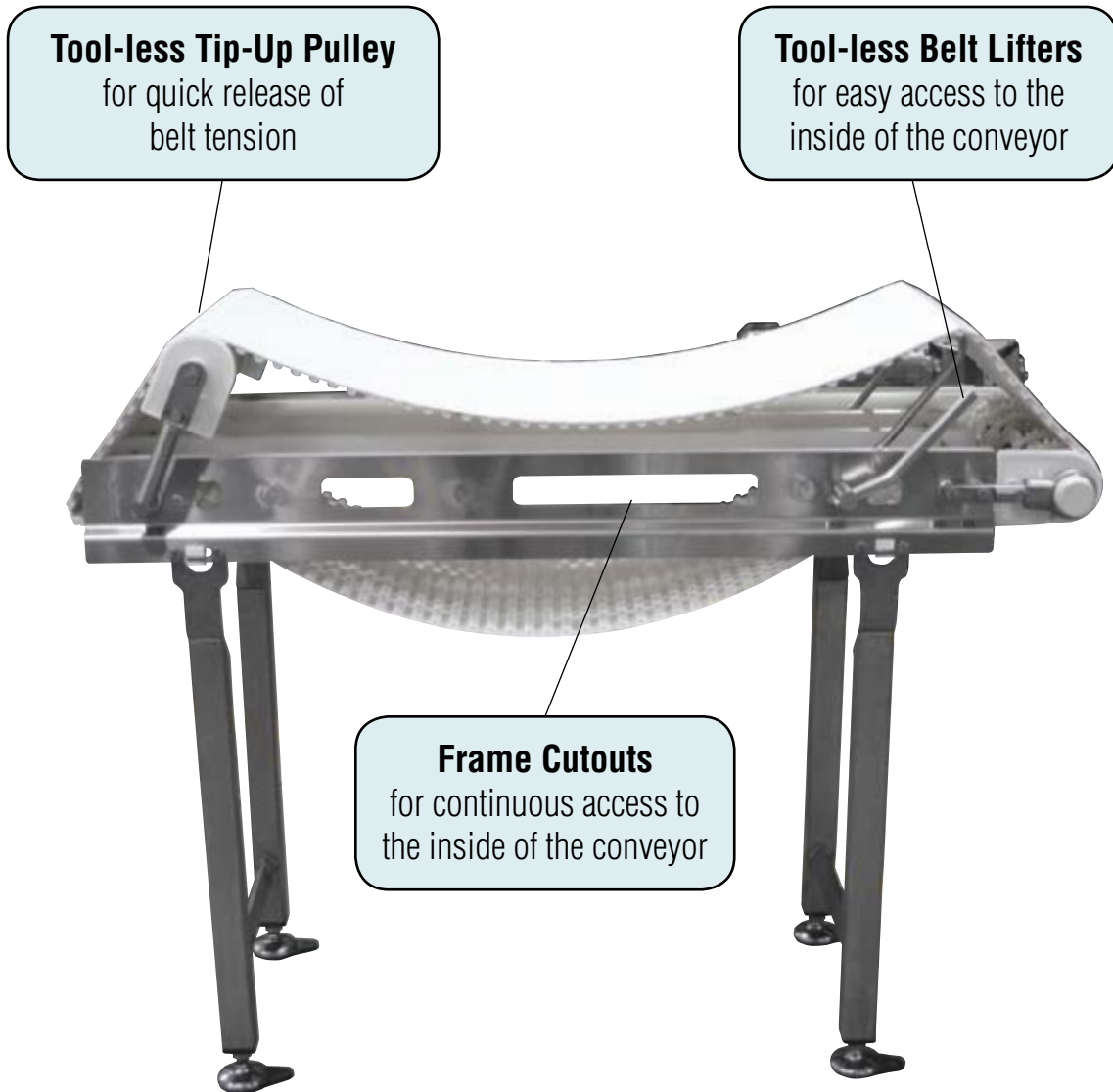

**Tool-less Tip-Up Pulley**  
for quick release of  
belt tension

**Tool-less Belt Lifters**  
for easy access to the  
inside of the conveyor

**Frame Cutouts**  
for continuous access to  
the inside of the conveyor

NO TOOLS REQUIRED!

Total time for cleaning preparation:  
**30 Seconds**

**Fast & Effective Sanitation Options for  
Complete Dis-Assembly & Cleaning**



**Fully Assembled**

to

**Completely  
Dis-Assembled  
in Minutes**

**Conveyor Cleaning Preparation\***

**1 Person**

**3 Minutes Per Section**

**No Problem!**

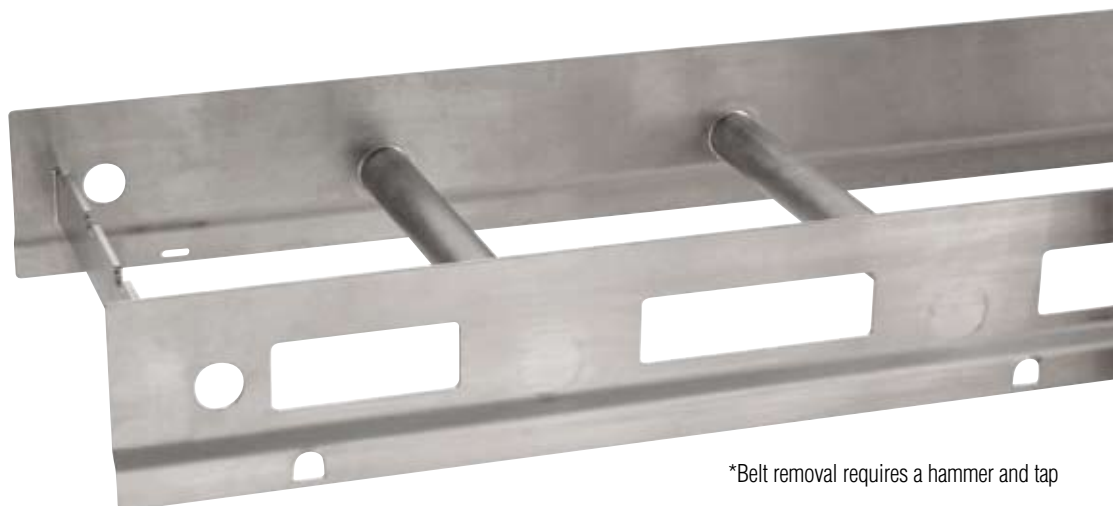

\*Belt removal requires a hammer and tap



## Specifications:

- Modular Flat, Modular Cleated and Curved Modular Flat Belt models
- Load: 20 lbs/square foot of belt (90 kg/m<sup>2</sup>)\*
- Belt speed: 233 ft/min maximum (71 m/min)
- Belt Widths: 6" (152 mm) to 60" (1,524 mm)
- Conveyor Lengths: 36" (914 mm) to 999" (25,375 mm)
- Degree of curves: 15° to 180°  
8" and 10" widths available in 30° increments  
12" through 36" widths available in 15° increments
- Maximum of 2 curves per conveyor with up to 240° total degrees of turns (*up to 4 curves is possible dependant upon length and degree of curves, consult factory*)
- Wear strip material is UHMW
- Continuous TIG welded 304 stainless steel frame
- #4 Polish on all outside surfaces
- Bearing material is 400 stainless steel
- Bearing lubricant is H1 type FDA lubricant
- FDA approved belting and plastic components



\* Conveyor load capacity depends on conveyor size, incline, motor position, accumulated loads and other factors.

## Features & Benefits:

- Frame is designed with no horizontal surfaces for optimum cleaning. Conveyors over 10' (3,048 mm) long consist of multiple sections which are bolted together.
- Bearings are mounted in cast stainless steel housings for maximum performance in washdown environments.
- Solid UHMW wear strips are easily lifted out of the frame without tools to minimize cleaning time.
- The tool-less tip up pulley allows conveyor end to be lifted easily for quick access to inside of conveyor for cleaning.
- Conveyor is designed to withstand high pressure (100-1,500 psi) spray and chlorinated solutions.
- The return belt supports are segmented plastic slide blocks and are easily removed without tools for effective cleaning.
- Drive sprockets are located on a 1.5" square stainless steel shaft without fasteners to provide optimum drive strength and cleanability.
- Frame cut-outs (optional) are available to allow spraying the inside of the conveyor without lifting the belt.
- Nose bar idler ends (optional) are constructed of a machined UHMW bar to provide a 1.5" diameter transfer.
- The nose bar drive configuration (optional) allows the use of the nose bar transfer on each end of the conveyor for small product transfers.
- Belt lifters (optional) raise the belt from the wear strips by simply pulling an external lever for fast access and effective cleaning.



Tip-Up Tail

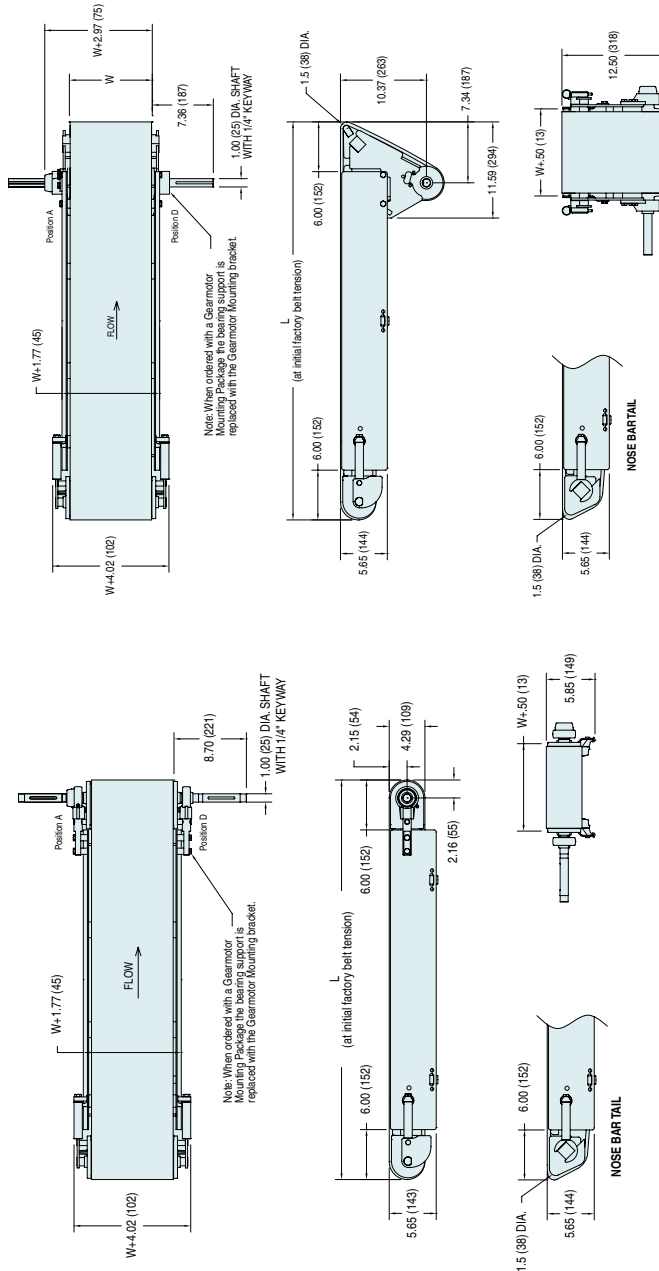

**STANDARD MODELS**



**Modular Flat Belt**



**Modular Cleated Belt**



**Curved Modular Flat Belt**

**STANDARD OPTIONS**

**Nose Bar Idler Pulley**  
1.5" (38 mm) diameter for tight transfers.



**Belt Lifters**

For easy cleaning on wide or long conveyors.



**Frame Cut-Out**

Allows access for internal frame washing.







## Specifications:

- Z-Frame Modular Flat and Cleated Belt models
- Loads up to 20 lbs/square foot of belt (90 kg/m<sup>2</sup>)\*
- Belt speed: 233 ft/min maximum (71 m/min)
- Belt Widths: 6" (152 mm) to 24" (610 mm)
- Section Lengths: 24" (610 mm) to 20' (6.1 m)
- Total Conveyor Lengths up to 40' (12.2 m)
- Z-Frame Modular Flat Belt has 5°, 10°, 15° & 30° Fixed Angle Modules standard (*inclines over 5° require friction insert belting*)
- Z-Frame Modular Cleated Belt has 15°, 30°, 45° & 60° Fixed Angle Modules standard
- Cleat height available in 25 mm & 76 mm
- Wear strip material is UHMW
- Continuous TIG welded 304 stainless steel frame
- #4 Polish on all outside surfaces
- Bearing material is 400 stainless steel
- Bearing lubricant is H1 type FDA lubricant
- FDA approved belting and plastic components



\* Conveyor load capacity depends on conveyor size, incline, motor position, accumulated loads and other factors.

## Features & Benefits:

- Frame is designed with no horizontal surfaces for optimum cleaning. Conveyors over 10' (3,048 mm) long consist of multiple sections which are bolted together.
- Bearings are mounted in cast stainless steel housings for maximum performance in washdown environments.
- Solid UHMW wear strips are easily lifted out of the frame without tools to minimize cleaning time.
- The tool-less tip up pulley allows conveyor end to be lifted easily for quick access to inside of conveyor for cleaning.
- Conveyor is designed to withstand high pressure (100-1,500 psi) spray and chlorinated solutions.
- The return belt supports are segmented plastic slide blocks and are easily removed without tools for effective cleaning.
- Drive sprockets are located on a 1.5" square stainless steel shaft without fasteners to provide optimum drive strength and cleanability.
- Frame cut-outs (optional) are available to allow spraying the inside of the conveyor without lifting the belt.
- Nose bar idler ends (optional) are constructed of a machined UHMW bar to provide a 1.5" diameter transfer.
- The nose bar drive configuration (optional) allows the use of the nose bar transfer on each end of the conveyor for small product transfers.
- Belt lifters (optional) raise the belt from the wear strips by simply pulling an external lever for fast access and effective cleaning.



Tip-Up Tail

**MODULAR FLAT BELT MODEL**

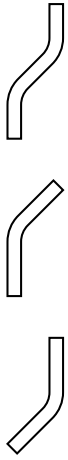
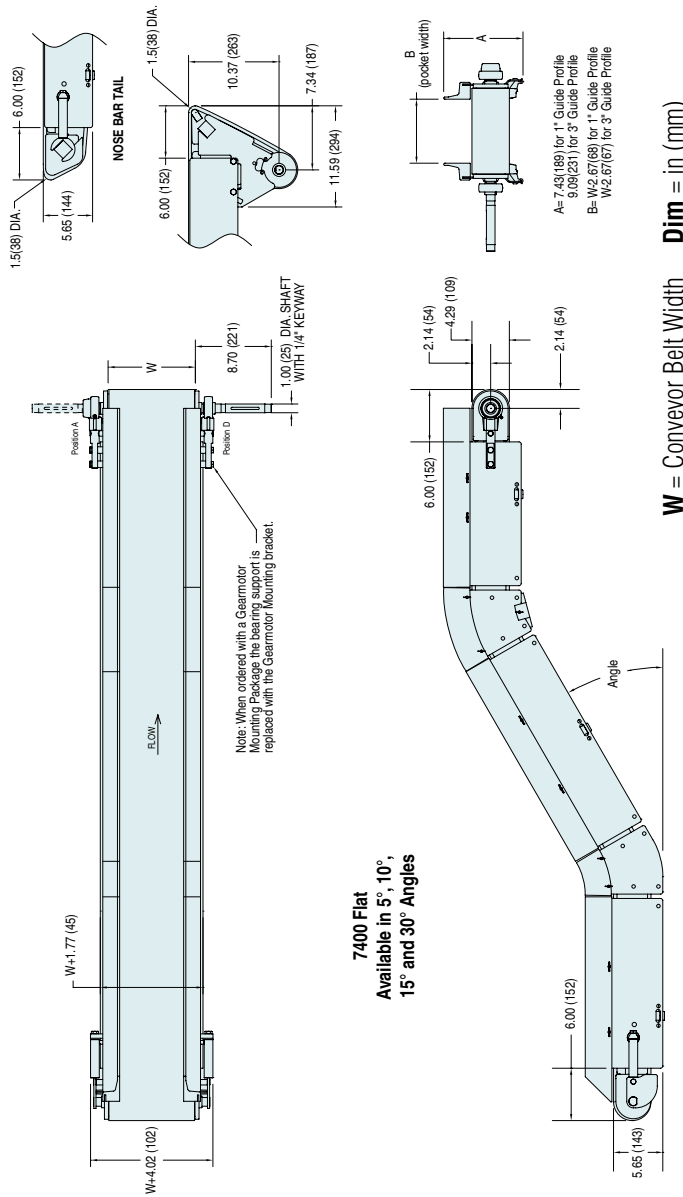

**Z-Frame Configurations**

**STANDARD OPTIONS**

**Nose Bar Idler Pulley**  
1.5" (38 mm) diameter for tight transfers.



**Belt Lifters**

For easy cleaning on wide or long conveyors.



**Frame Cut-Out**

Allows access for internal frame washing.



**STANDARD MODELS**

**Z-Frame Modular Flat Belt**

**Z-Frame Modular Cleaned Belt**

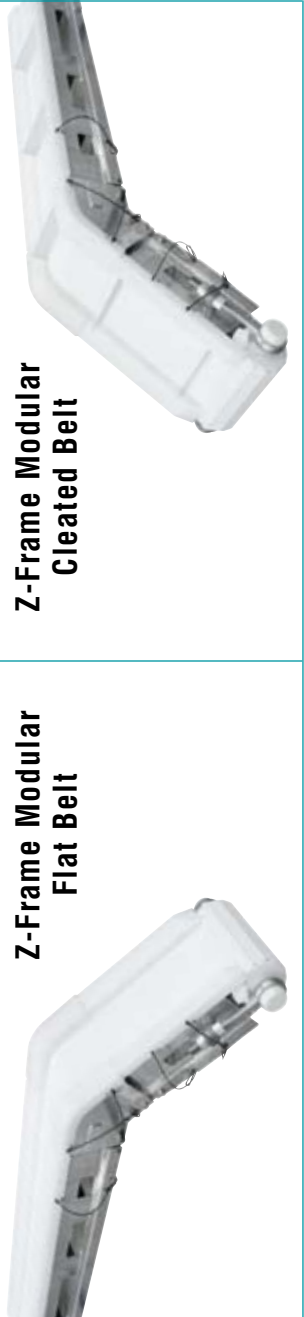



## Specifications:

- Loads up to 20 lbs/roller
- Roller widths: 8", 12", 18", 24", 30", & 36"
- Conveyor lengths: 36" to 120" in 3" increments
- Frame is all welded with round cross members
- Frames outer surface is a #4 finish with 2B on internal components
- Roller centers 3" and 6"
- Standard Hollow Tube roller 1.9" diameter
- Solid Acetal roller 2" diameter
- Hollow Tube rollers are 304 SS hollow tubes with a 2B finish
- Solid Acetal roller ends are located in a UHMW guide bar
- Hollow Tube roller ends are spring loaded 7/16" hex shaft
- Stands are stainless steel tube with adjustable foot and thread guards
- Solid Acetal roller is designed to USDA Red Meat & Poultry standards

## Features & Benefits:

- Frame is constructed of continuous TIG welded 304 stainless steel for durability in tough applications
- Integral 1" high side for product containment or low side for maximum flexibility
- Solid Acetal rollers simply lift out of UHMW guide for quick for access to frame during cleaning
- Solid Acetal UHMW guides removable without tools for complete access to frame during cleaning
- Hollow Tube spring loaded roller can be removed quickly for access to frame during cleaning
- Optional welded end stop available for durability



**Stainless Steel Gravity  
Roller: Hollow Tube**



**Stainless Steel Gravity  
Roller: Solid Acetal**

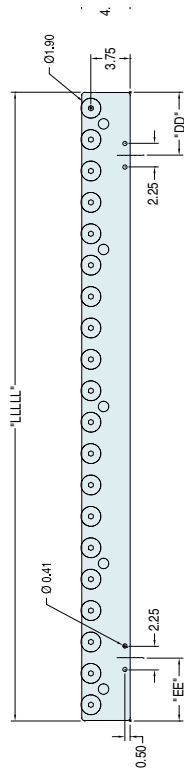
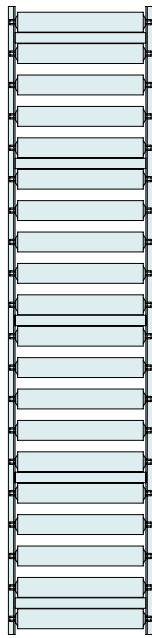

- \* Recommended minimum angle of decline is 5 degrees for products greater than 10 lbs.
- \* Recommended minimum angle of decline is 7-10 degrees for products less than 5 lbs.
- \* Recommended 3 rollers are in contact with the product.

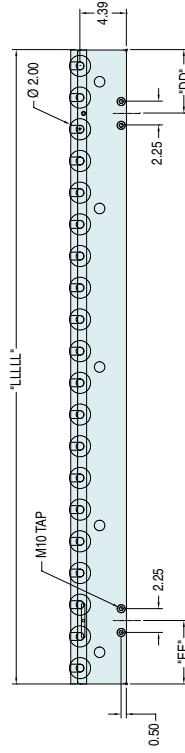
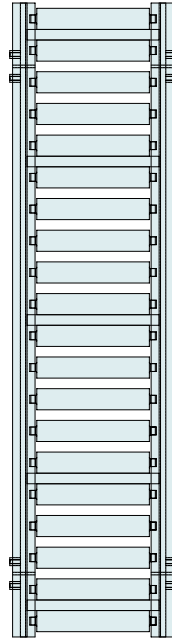
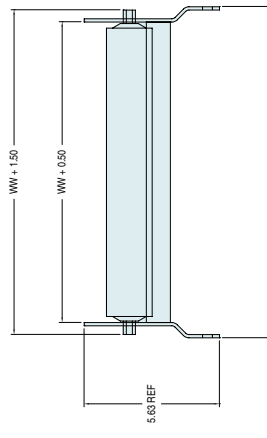

- \* Recommended minimum angle of decline is 5 degrees for products greater than 10 lbs.
- \* Recommended minimum angle of decline is 10 degrees for products less than 5 lbs.
- \* Recommended 3 rollers are in contact with the product.

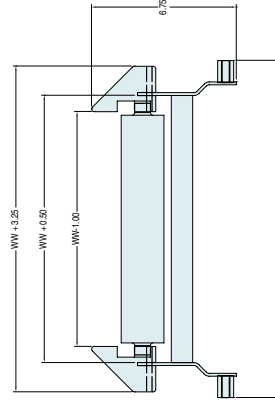

**STANDARD MODELS**



**Hollow Tube  
Stainless Steel  
Roller Conveyors**



**Solid Acetal Stainless  
Steel Roller Conveyors**

For more information, go to [www.dorner.com](http://www.dorner.com). Call 800.397.8664 or 262.367.7600.  
Due to the wide variety of drive set ups and applications, point of installation guarding is the responsibility of the end user.

# Designed to transport Food & Pharmaceutical product with confidence while keeping operators safe.



**Tool-Less  
Tip-up Pulley**

For quick release of belt tension.



**V-Guided  
Belting**

For positive belt tracking.

**Nose Bar  
Transfer Option**  
for small product  
transfers. Available in:  
1/2", 1" and 1 7/8".



**Cast On Urethane  
Lagged Pulley**

Ensures a permanent  
sanitary bond.



**Belt Tension System**  
with welded Bearing Support for tensioning  
and tracking with ACME threads





Eliminate horizontal surfaces for complete drainage.



Quickly removed without tools for cleaning. Most pieces are identical & completely interchangeable.

Full Range of Sanitary Belting Options

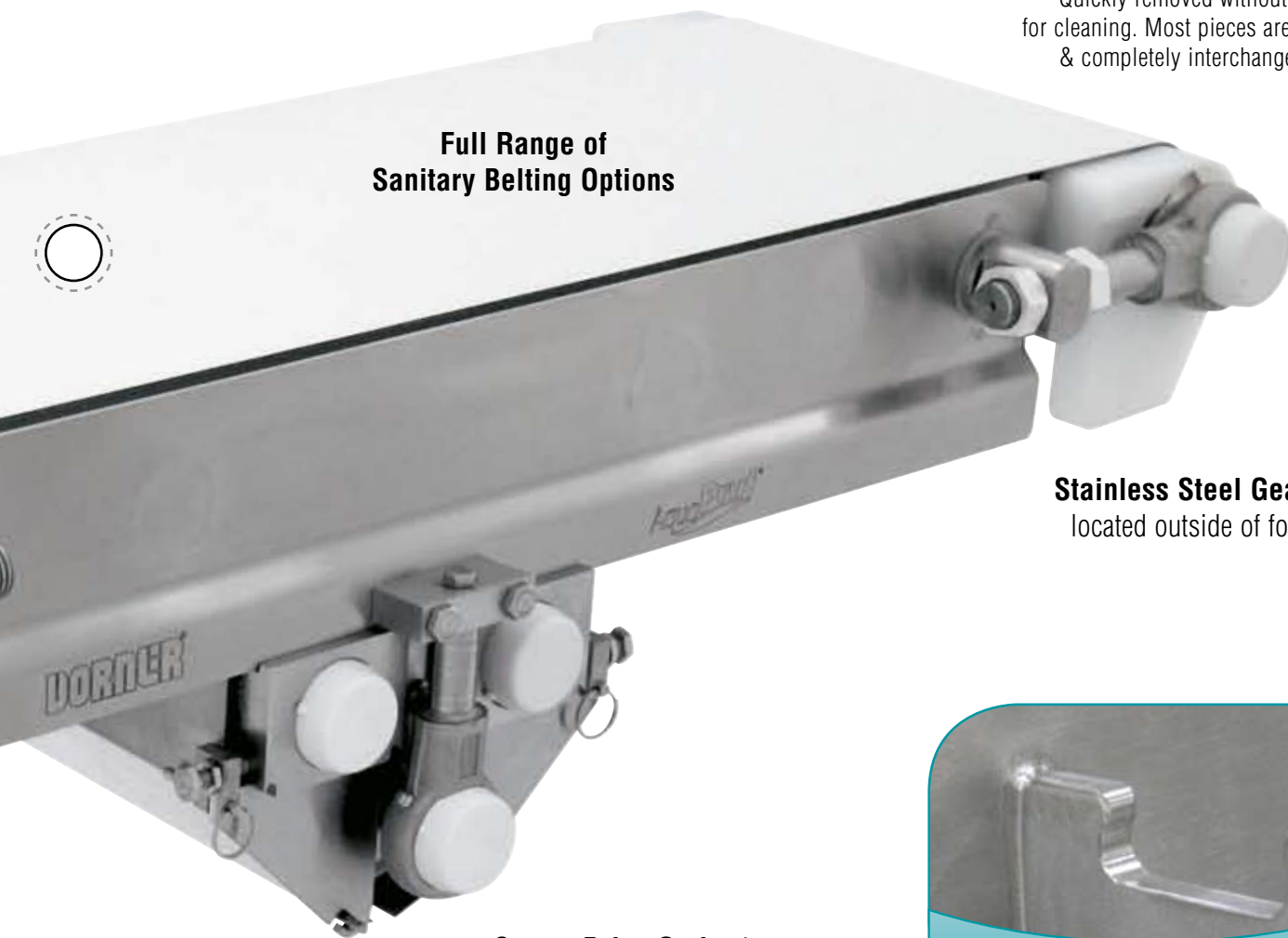

Stainless Steel Gearmotors located outside of food zone.

Center Drive Option\* for dual Nose Bar Transfers and increased end clearance. Tool-less disassembly for quick sanitation.



Eliminates fasteners in food zone. (Continuous TIG welding)



\* Patent Pending

## Fast & Effective Sanitation Options for Daily Cleaning

**Tool-less Belt Lifters**  
for easy access to the inside of the conveyor

**Tool-less Tip-Up Pulley**  
for quick release of belt tension

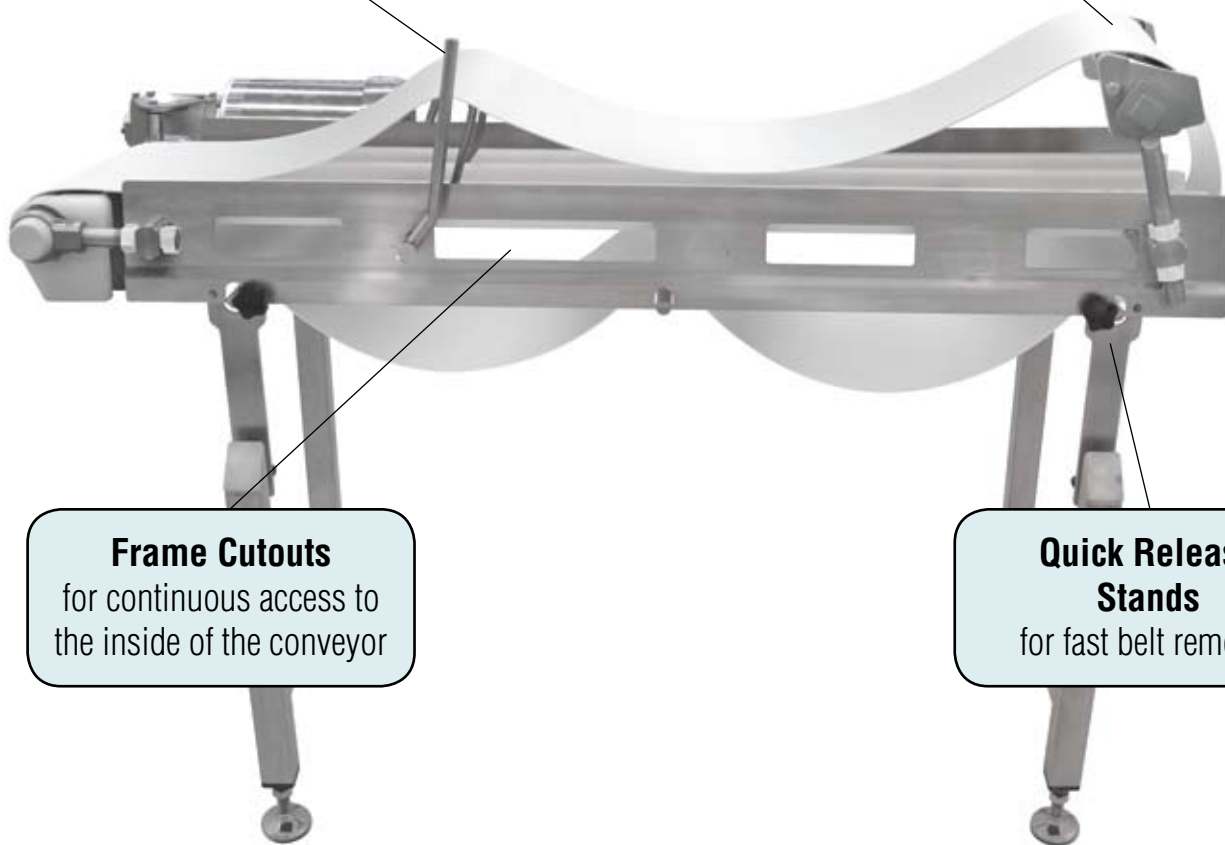

**Frame Cutouts**  
for continuous access to the inside of the conveyor

**Quick Release Stands**  
for fast belt removal

NO TOOLS REQUIRED!

Total time for cleaning preparation:  
**30 Seconds**

**Fast & Effective Sanitation Options for  
Complete Dis-Assembly & Cleaning**



**Fully Assembled**

to

**Completely  
Dis-Assembled  
in Minutes**

**Conveyor Cleaning Preparation**

**1 Person**

**3 Minutes Per Section**

**No Problem!**

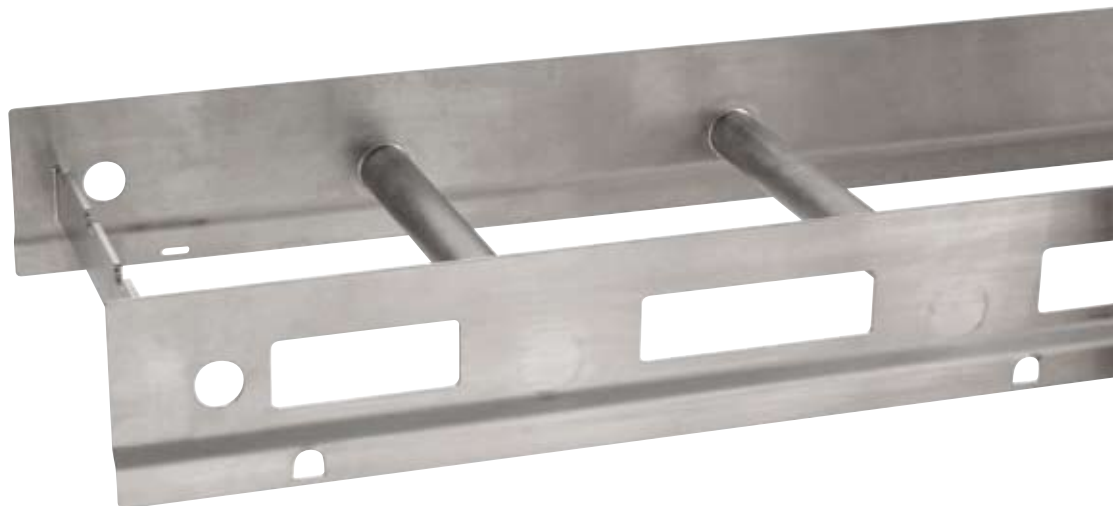



\* Conveyor load capacity depends on conveyor size, incline, motor position, accumulated loads and other factors.

## Specifications:

- Flat, Cleated Belt End Drive and Flat Belt Center Drive models
- Load: 20 lbs/square foot of belt (90 kg/m<sup>2</sup>)\*
- Belt speed: 328 ft/min maximum (100 m/min)
- Belt Widths: 6" (152 mm) to 60" (1,524 mm)
- Conveyor Lengths: 36" (914 mm) to 40' (12.2 m)
- 3.5" (89 mm) diameter drive roller with cast-on Urethane lagging
- UHMW Wear strip bed plate
- Continuous TIG welded 304 stainless steel frame
- #4 Polish on all outside surfaces
- Bearing material is 400 stainless steel
- Bearing lubricant is H1 type FDA lubricant
- FDA approved belting and plastic components

## Features & Benefits:

- Frame is designed with no horizontal surfaces for optimum cleaning. Conveyors over 10' (3,048 mm) long consist of multiple sections which are bolted together.
- Bearings are mounted in cast stainless steel housings for maximum performance in washdown environments.
- Center Drives allow additional clearance on ends when needed. Unique tool-less construction for guarding and back bend rollers.
- Belt tensioning mechanism uses Acme threads for easy cleaning and is externally mounted to the frame with adequate clearances for cleaning.
- The tool-less tip up pulley allows conveyor end to be lifted easily for quick access to inside of conveyor for cleaning.
- Conveyor is designed to withstand high pressure (100-1,500 psi) spray and chlorinated solutions.
- Return Belt Supports are 4" UHMW Rollers and are easily removed without tools for effective cleaning.
- Drive spindle is Cast-On Urethane Lagging for increased load capacity. Spindle has groove for V-guided belts for optimum performance.
- Frame cut-outs (optional) are available to allow spraying the inside of the conveyor without lifting the belt.
- Nose bar idler ends (optional) are available in 1/2", 1" & 1 7/8" for small product transfers.
- Belt lifters (optional) lift belt from wear strips / bed plate by simply pulling an external lever for fast access and effective cleaning.
- Belt scraper (optional) removes build up and adjusts easily for each application. Features tool-less disassembly/assembly for cleaning of parts.
- Solid bed plate (optional) is stainless steel and locates on UHMW strips for delicate / fragile products.



**OPTIONAL:  
Bed Plates**

Provides continuous support for delicate product (dry applications only).

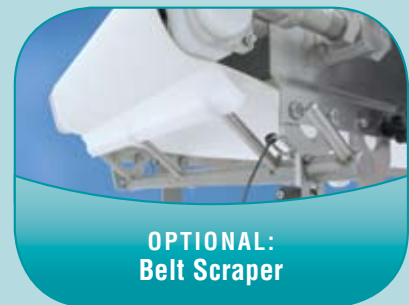

**OPTIONAL:  
Belt Scraper**

UHMW blade removes build-up and is easily adjusted.



**Tool-less Quick  
Removal Pulleys**

**END DRIVE MODEL**

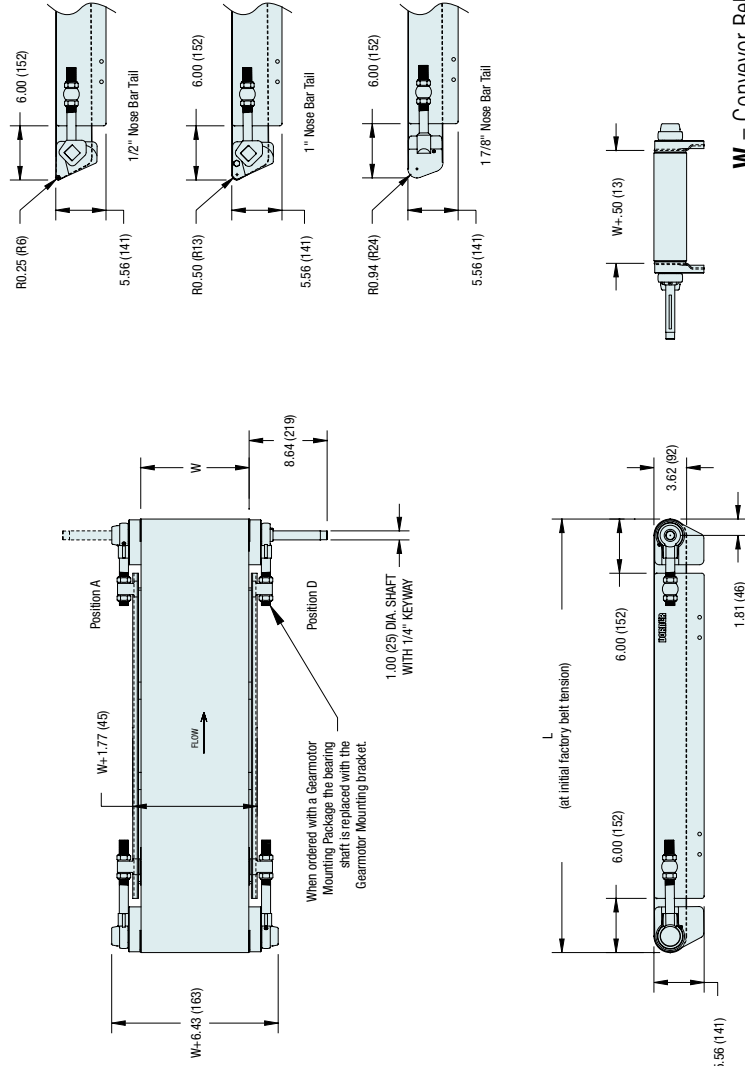

**STANDARD MODELS**



**Flat Belt End Drive**



**Flat Belt Center Drive**



**Cleated Belt End Drive**

**STANDARD OPTIONS**

**Tip-Up Tail**



**Belt Lifters**

For easy cleaning on wide or long conveyors.



**Frame Cut-Out**

Allows access for internal frame washing.



**Bed Plates**

Provides continuous support for delicate product (dry applications only).







## Specifications:

- Z-Frame Modular Flat and Cleated Belt models
- Load: 20 lbs/square foot of belt (90 kg/m<sup>2</sup>)
- Belt speed: 233 ft/min maximum (71 m/min)
- Belt Widths: 6" (152 mm) to 24" (610 mm)
- Conveyor Lengths: 24" (610 mm) to 20' (6.1 m)
- Total Conveyor Lengths: up to 40' (12.2 m)
- Z-Frame Modular Flat Belt has 5°, 10° and 15° Fixed Angle Modules standard
- Z-Frame Modular Cleated Belt has 30°, 45° and 60° Fixed Angle Modules standard
- 3.5" (89 mm) diameter drive roller with cast-on Urethane lagging
- UHMW Wear strip bed plate
- Continuous TIG welded 304 stainless steel frame
- #4 Polish on all outside surfaces
- Bearing material is 400 stainless steel
- Bearing lubricant is H1 type FDA lubricant
- FDA approved belting and plastic components

\* Conveyor load capacity depends on conveyor size, incline, motor position, accumulated loads and other factors.

## Features & Benefits:

- Frame is designed with no horizontal surfaces for optimum cleaning. Conveyors over 10' (3,048 mm) long consist of multiple sections which are bolted together.
- Bearings are mounted in cast stainless steel housings for maximum performance in washdown environments.
- Solid UHMW wear strips are easily lifted out of the frame without tools to minimize cleaning time.
- Belt tensioning mechanism is externally mounted to the frame with adequate clearances for cleaning. No external threads are used.
- The tool-less tip up pulley allows conveyor end to be lifted easily for quick access to inside of conveyor for cleaning.
- Conveyor is designed to withstand high pressure (100-1,500 psi) spray and chlorinated solutions.
- The return belt supports are segmented plastic slide blocks and are easily removed without tools for effective cleaning.
- Drive spindle is Cast-On Urethane Lagging for increased load capacity. Spindle has groove for V-guided belts for optimum performance.
- Frame cut-outs (optional) are available to allow spraying the inside of the conveyor without lifting the belt.
- Nose bar idler ends (optional) are constructed of a machined UHMW bar to provide a 1.5" diameter transfer.
- The nose bar drive configuration (optional) allows the use of the nose bar transfer on each end of the conveyor for small product transfers.
- Belt lifters (optional) raise the belt from the wear strips by simply pulling an external lever for fast access and effective cleaning.



**OPTIONAL:  
Belt Scraper**

UHMW blade removes build-up and is easily adjusted.

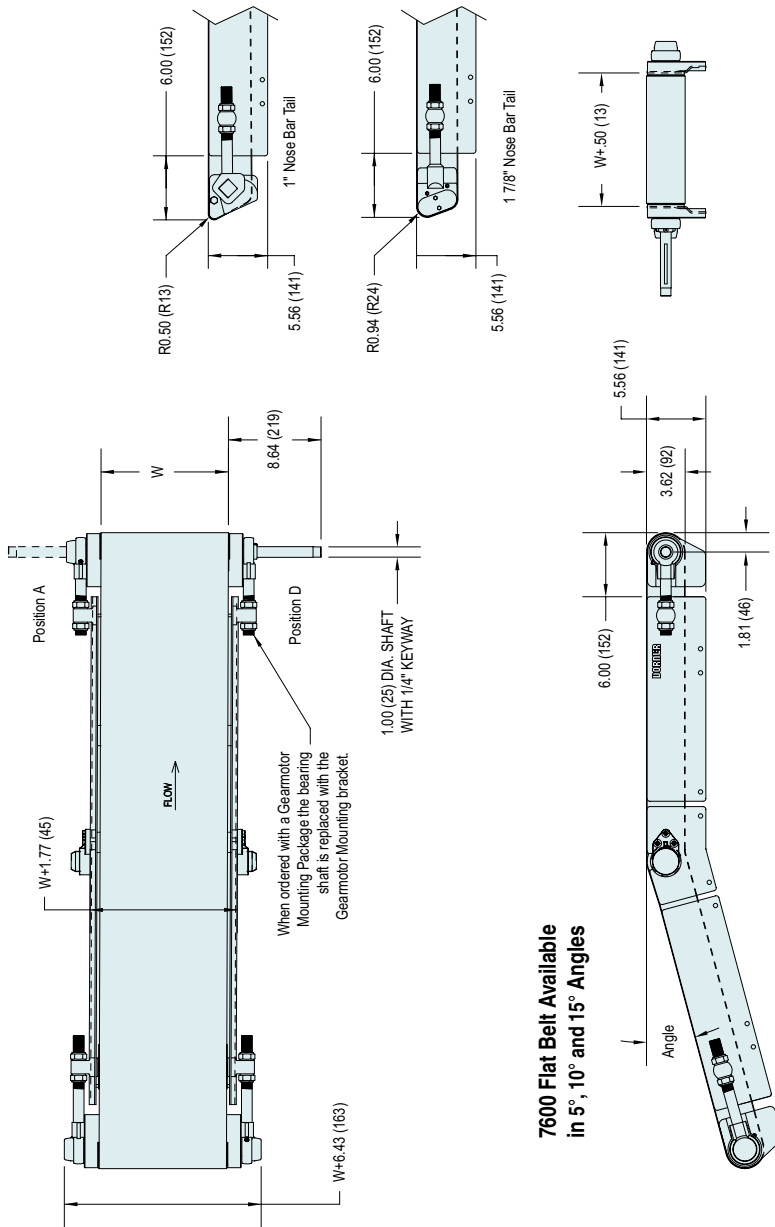

**7600 Flat Belt Available in 5°, 10° and 15° Angles**

**W = Conveyor Belt Width Dim = in (mm)**

**STANDARD MODELS**



**Z-Frame Flat Belt End Drive**



**Z-Frame Cleated Belt End Drive**

**STANDARD OPTIONS**

**Tip-Up Tail**



**Belt Lifters**

For easy cleaning on wide or long conveyors.



**Frame Cut-Out**

Allows access for internal frame washing.



**Bed Plates**

Provides continuous support for delicate product (dry applications only).





## Specifications:

- Modular Flat, Modular Cleated and Curved Modular Flat Belt models
- Z-Frame Modular Flat and Cleated models
- Load: 20 lbs/square foot of belt (90 kg/m<sup>2</sup>)
- Belt speed: 233 ft/min maximum (71 m/min)
- Belt Widths: 6" (152 mm) to 36" (914 mm)
- Conveyor Lengths: 36" (914 mm) to 999" (25,375 mm)
- UHMW Wear strip bed plate
- Continuous TIG welded 304 stainless steel frame
- #4 Polish on all frame surfaces
- Bearing material is 400 stainless steel
- Bearing lubricant is H1 type FDA lubricant
- USDA Approved belting and plastic components
- Meets USDA, NSF & AMI design specifications

## Features & Benefits:

- Frame is designed with no horizontal surfaces for optimum cleaning. Conveyors over 10' (3,048 mm) long consist of multiple sections which are bolted together (can be welded together on site).
- Bearings are mounted in cast stainless steel housings for maximum performance in washdown environments.
- Solid UHMW wear strips are easily lifted out of the frame without tools to minimize cleaning time.
- The tool-less tip up pulley allows conveyor end to be lifted easily for quick access to inside of conveyor for cleaning.
- Open Belt Tracking Flanges and solid UHMW idler pucks create access to pulleys.
- Conveyor is designed to withstand high pressure (100-1,500 psi) spray and chlorinated solutions.
- The return belt supports are segmented plastic slide blocks and are easily removed without tools for effective cleaning.
- Drive sprockets are located on a 1.5" square stainless steel shaft without fasteners to provide optimum drive strength and cleanability.
- Nose bar idler ends (optional) are constructed of a machined UHMW bar to provide a 1.5" diameter transfer.
- The nose bar drive configuration (optional) allows the use of the nose bar transfer on each end of the conveyor for small product transfers.
- Frame cut-outs (optional) are available to allow spraying the inside of the conveyor without lifting the belt.
- Belt lifters (optional) raise the belt from the wear strips by simply pulling an external lever for fast access and effective cleaning.
- TIG welded stand offs keep fasteners out of the food zone.



Available in Idler Tail

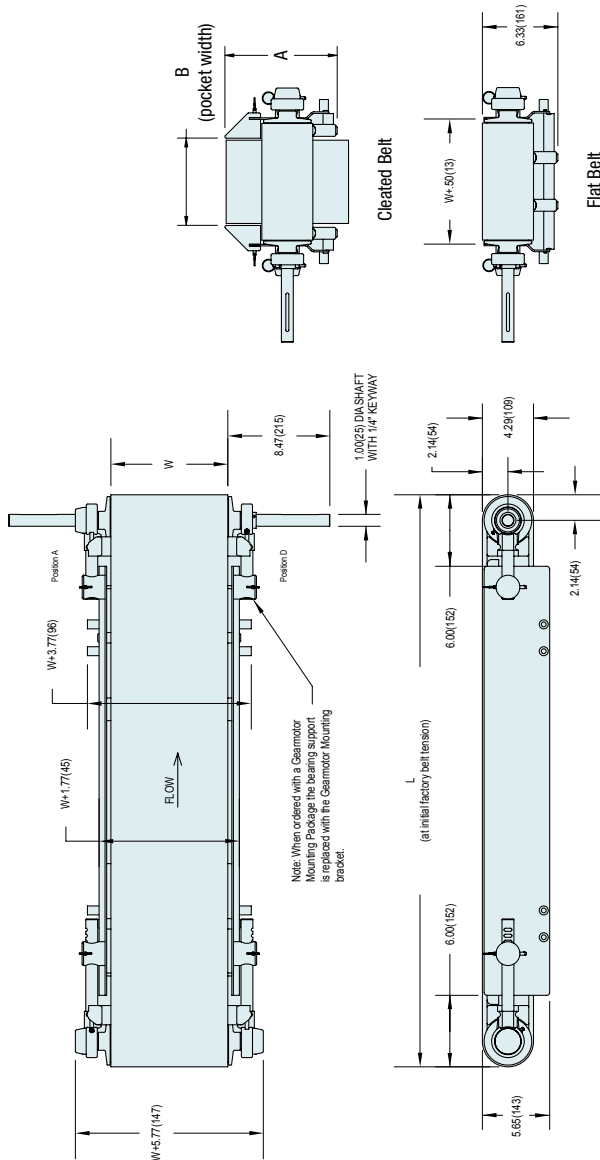

W = Conveyor Belt Width Dim = in (mm)

**CONFIGURATIONS AVAILABLE**

**Straight**  
Flat & Cleated Modular Belt



**Nose-Over**  
Flat & Cleated Modular Belt

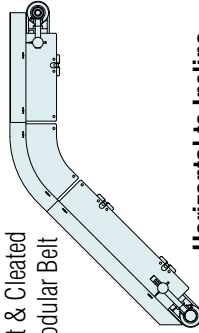

**Horizontal to Incline**  
Cleated Modular Belt

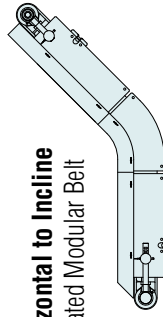

**Z-Frame**  
Cleated Modular Belt

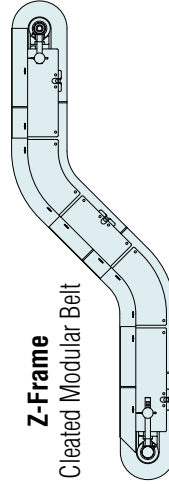

**Curve**  
Flat Modular Belt

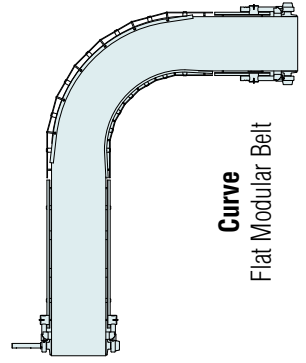

**STANDARD OPTIONS**



**Nose Bar Idler Pulley**  
1.5" (38 mm) diameter for tight transfers.



**Belt Lifters**  
For easy cleaning on wide or long conveyors.



**Frame Cut-Out**  
Allows access for internal frame washing.



## Specifications:

- Load: 20 lbs/square foot of belt (90 kg/m<sup>2</sup>)
- Belt Widths: 6" (152 mm) to 36" (914 mm)
- Lengths: 36" (914 mm) to 40' (12.2 m)
- Belt speed: 233 ft/min maximum (71 m/min)
- Solid urethane belting, includes Belt Scraper
- UHMW Wear strip bed plate
- Continuous TIG welded 304 stainless steel frame
- #4 Polish on all frame surfaces
- Bearing material is 400 stainless steel
- Bearing lubricant is H1 type FDA lubricant
- USDA Accepted Belting
- Meets USDA, NSF & AMI design specifications

## Features & Benefits:

- Frame is designed with no horizontal surfaces for optimum cleaning. Conveyors over 10' (3,048 mm) long consist of multiple sections which are bolted together (can be welded together on site).
- Bearings are mounted in cast stainless steel housings for maximum performance in washdown environments.
- Solid UHMW wear strips are easily lifted out of the frame without tools to minimize cleaning time.
- The tool-less tip up pulley allows conveyor end to be lifted easily for quick access to inside of conveyor for cleaning.
- Solid Urethane belt is sprocket driven for consistent performance and has no bacteria harboring hinges or pins.
- Open Belt Tracking Flanges and solid UHMW idler pucks create access to pulleys.
- Return Belt Supports are 4" UHMW Rollers and are easily removed without tools for effective cleaning.
- Conveyor is designed to withstand high pressure (100-1,500 psi) spray and chlorinated solutions.
- Drive sprockets are located on a 1.5" square stainless steel shaft without fasteners to provide optimum drive strength and cleanability.
- Frame cut-outs (optional) are available to allow spraying the inside of the conveyor without lifting the belt.
- Belt lifters (optional) raise the belt from the wear strips by simply pulling an external lever for fast access and effective cleaning.
- TIG welded stand offs keep fasteners out of the food zone.



**Belt Scraper**

UHMW blade removes build-up & is easily adjusted



**Positive Drive**



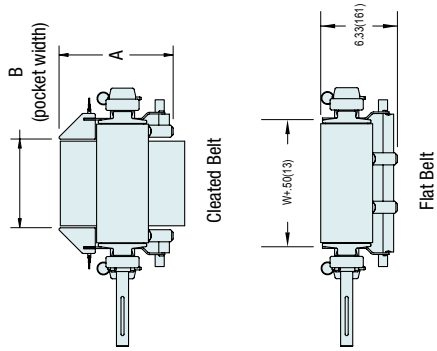
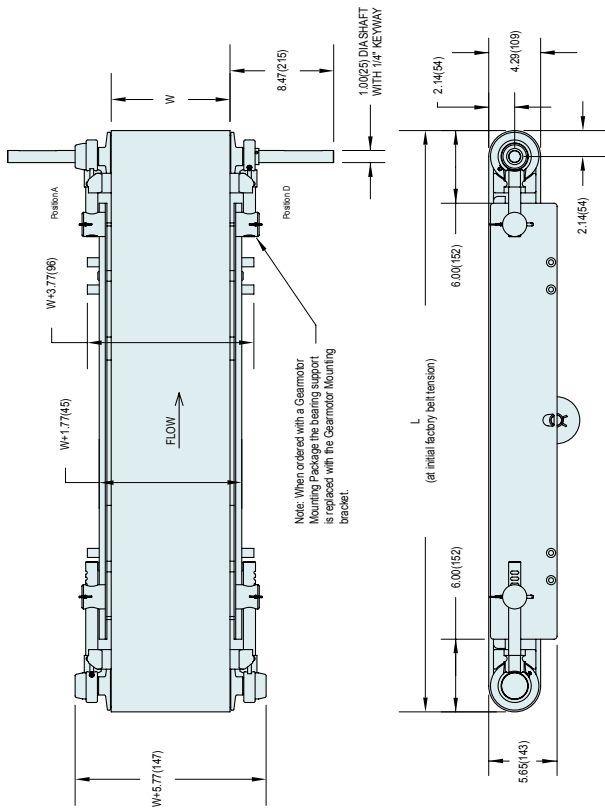

W = Conveyor Belt Width Dim = in (mm)

**CONFIGURATIONS AVAILABLE**

**Straight**  
Flat & Cleated Belt

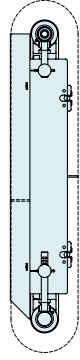

**Horizontal to Incline**  
Flat & Cleated Belt

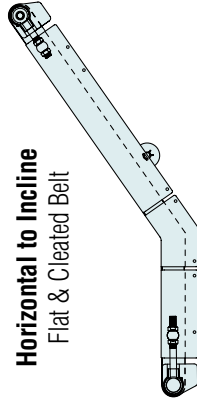

**Nose-Over**  
Flat & Cleated Belt

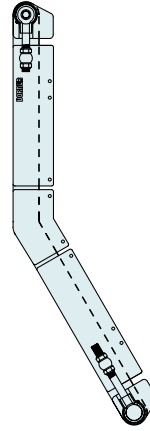

**Z-Frame**  
Cleated Belt

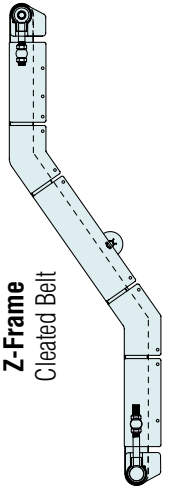

**STANDARD OPTIONS**



**Belt Lifters**

For easy cleaning on wide or long conveyors.



**Frame Cut-Out**

Allows access for internal frame washing.

# PROFILES

Choosing the right profile is an important step in the overall conveyor selection process. Application factors to consider include product thickness, product stability and accuracy in relation to the conveyed product. Other requirements may include side transfers, merges and accumulating products. Guides can be drilled, trimmed and cut to fit custom applications.

*(The featured 3D models were created using Dorner's 3D CAD Library. The 3D CAD Library is available to you on our website at [www.dorner.com](http://www.dorner.com))*

## 7350 & 7360 SERIES

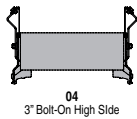
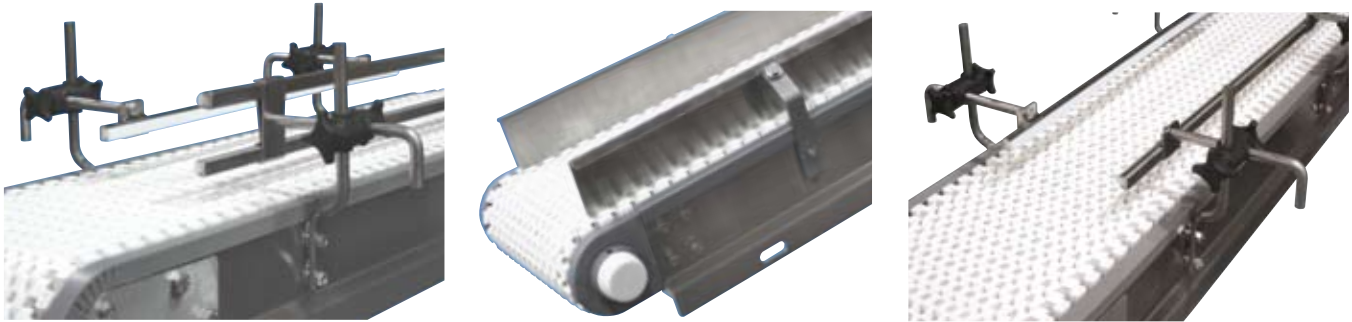

04  
3" Bolt-On High Side

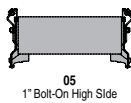

05  
1" Bolt-On High Side

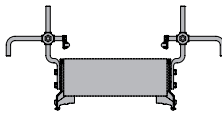

13  
Fully Adjustable Round

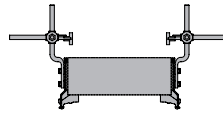

17  
Fully Adjustable Flat

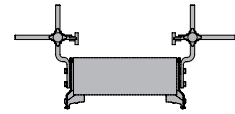

18  
Fully Adjustable Flat  
w/ Tool-less Handles

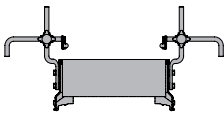

14  
Fully Adjustable Round  
w/ Tool-less Handles

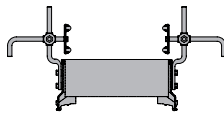

15  
Fully Adjustable Twin Rail

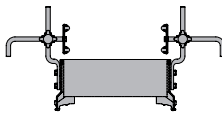

16  
Fully Adjustable Twin Rail  
w/ Tool-less Handles

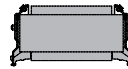

02  
1" Bolt-On High Side

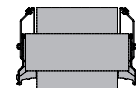

03  
3" Bolt-On High Side

## 7400 & 7600 SERIES



Profile 1  
Low Side



Profile 2  
1" (25) High Side

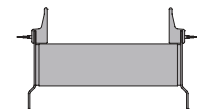

Profile 4  
3" (76) High Side

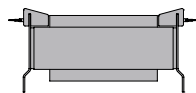

Profile for Cleat  
Types A, G, J, M, N & R

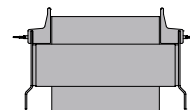

Profile for Cleat  
Types B, C, K, L, P, Q, S & T

## STANDARD BELTING

Dorner has a selection of standard belting for most common conveyor applications. Standard belt material is stocked at Dorner, then cut and spliced at the factory for fast conveyor shipment.



**Accumulation Belts**



**General Purpose Belts**



**High Friction Belts**



**Electrically Conductive Belts**



**Cleated Belts**

## SPECIALTY BELTING

For your special conveyor needs, Dorner has a large selection of specialty belting options available. Specialty belt material is not stocked at Dorner and needs to be custom ordered for your conveyor.

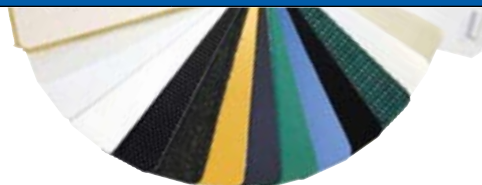

**Color Contrasting Belts**



**Chemical Resistant Belts**



**Solid Urethane Belts**



**FDA Sealed Edge Belts**



**FDA Encased Belts**

## MODULAR PLASTIC BELTING

Modular Plastic Belting is available in various flat top and cleated styles. Choose from open mesh, closed mesh, cleated and sidewall cleated belts with many options in frictions, temperature ratings and chemical resistance.

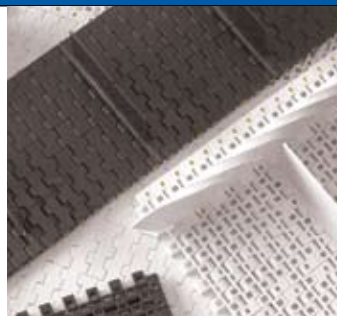

**Friction Inserts**



**Flat Top Belts**



**Flush Grid Belts**

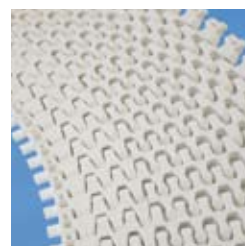

**Curve Belts**



**Cleated Belts**

# GEARMOTORS & MOUNTING PACKAGES

Gearmotors can be mounted to the conveyor with these standard mounting packages. Each package allows several position options and is available in both 90° and Parallel gearmotor configurations allowing you great flexibility. Mounting packages that utilize timing belts and pulleys also provide a wide range of belt speed options.

*(The featured 3D models were created using Dorner's 3D CAD Library. The 3D CAD Library is available to you on [www.dornercad.com](http://www.dornercad.com))*



## SIDE MOUNTS



Side mounts couple the conveyor and gearmotor with a flexible coupling or directly. Used for taller parts or where space below the conveyor is limited.

90° Gearmotor Orientations

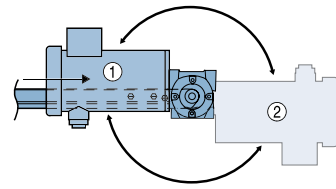

## BOTTOM MOUNTS



Bottom mounts utilize timing belts and pulleys for a wide variety of belt speed options. Used for taller parts and provides the most compact package.

90° Gearmotor Orientations

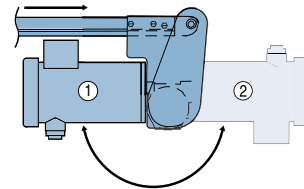

## CENTER MOUNTS



Frees up both ends of conveyor for machine interface and maintenance free belt take-up.

## GEARMOTORS & CONTROLS

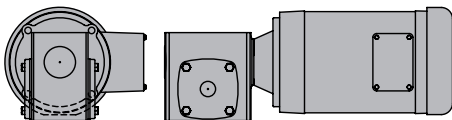

90° Gearmotors

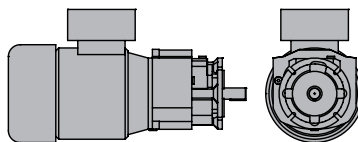

Parallel Shaft Gearmotors

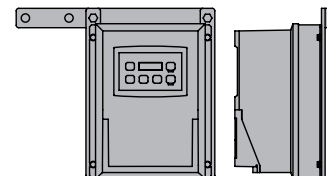

Variable Speed Controllers



## SANITARY CONVEYOR SUPPORT STANDS & ACCESSORIES

Dorner offers the most complete line of conveyor support stands available.

### Features & Benefits

- Widths: 4 in to 60 in (102 mm to 1,524 mm)
- Heights: 7 in to 99 in (178 mm to 2,515 mm)
- Complete stainless steel construction with a 2B or #4 finish
- Vertical legs are formed channel or a closed 2" square tube
- Has +/- 2" of adjustment
- Fixed Foot self aligns 10° for sloped floors
- Horizontal Mount Version for Direct Level Conveyor Mounting
- Incline Mount Version for angled conveyor applications
- Designed for Washdown Environments

### Accessories

- Casters
- Diagonal bracing
- Floor Anchor Kits
- Ceiling Supports

*AquaGard*<sup>®</sup>

*AquaPruf*<sup>®</sup>

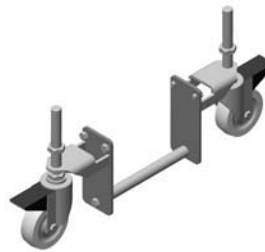

Low Height Support Stands



Tall Support Stands



Swivel Locking Casters



Adjustable Angle Support Stands



Formed Channel Support Stands



Closed 2" Square Tube Support Stands

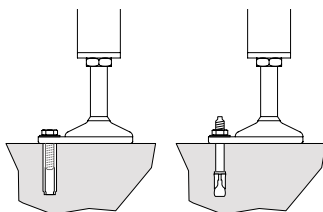

Sanitary Floor Anchor Kits



Ceiling Supports

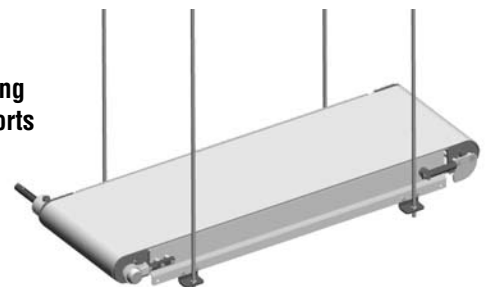



## POWERED TRANSFER

### Features & Benefits

- 1/2" diameter nose rollers for small part transfer
- Adjustable height and distance to main roller for fine tuning the product transfer
- High speed positive drive conveyor belts to ensure consistent speed
- Maintains product speed through transfer for gapping and pacing
- Located at drive and/or idler end of main conveyor
- Compatible with both curve and straight conveyors
- Compatible with all end drive tails and drive mount packages
- Made of corrosion resistant materials for wipe down or occasional wash down
- Slave driven from main roller for minimal install requirements

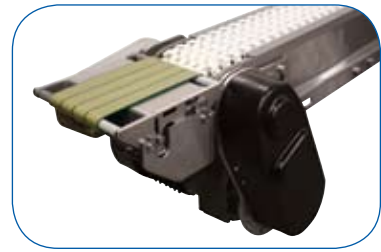
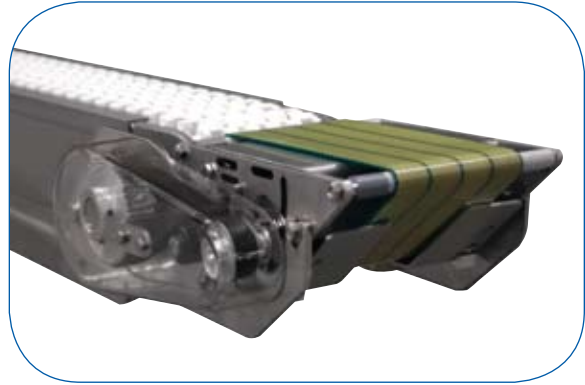

### Conveyor Specifications:

**Conveyor Width:** 4" wide to 36" wide in 2" increments

**Conveyor Length:** Adds less than 8" to conveyor length

**Conveyor Speed:** Up to 175 ft/min

#### Slave Drive Speed Options:

- Same Speed
- Speed Up by 1.6 : 1
- Speed Down by 1.25 : 1

### General Specifications

- FDA approved 1/2" diameter self lubricated nose bar bushings
- Positive drive FDA approved urethane belting
- 300 series stainless steel / anodized aluminum construction
- Plated corrosion resistant bearings
- Used on infeed and exit tail
  - For infeed tail : Needs conveyor to be ordered with output shaft tail
  - For exit tail : Needs conveyor to be ordered with dual output shaft tail
- Can be purchased as a conveyor only
  - Does not include mounting brackets or slave drive
  - Includes output shaft only

**Reduce Product Loss**

**Space Saving Design**

**Slave Driven**

## MOTORIZED PULLEY

### Features & Benefits

- 304 stainless steel for durability in tough applications
- Sealed drum motor is ideal for heavy duty washdown applications
- Pulley locating supports allow for fast removal and relocating for sanitation
- No fasteners are used to locate sprockets on motorized pulley
- Innovative sprocket locating key way allows for fast and effective sanitation (Patent Pending)

### General Specifications:

- 7400 and 7400 Ultimate Stainless Steel Sprocket model (photo #1)
- 7600 Molded Urethane Lagging model (photo #2)
- 7600 Ultimate Plastic Sprocket model (photo #3)
- Motorized Pulley Widths: 12" to 46" in 2" increments
- All external components are stainless steel
- Pulley located in conveyor frame with welded supports
- Pulley supports have quick locating and removal slot
- All frame components are a #4 finish
- Completely sealed components ideal for sanitary applications
- 50,000 hours of operation between oil changes
- 96% mechanically efficient
- Saves up to 30% power consumption over conventional motors
- 230 or 460 Volt 3 Phase
- VFD variable speed capable
- Speeds to 270 feet per minute

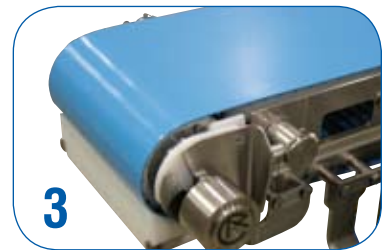
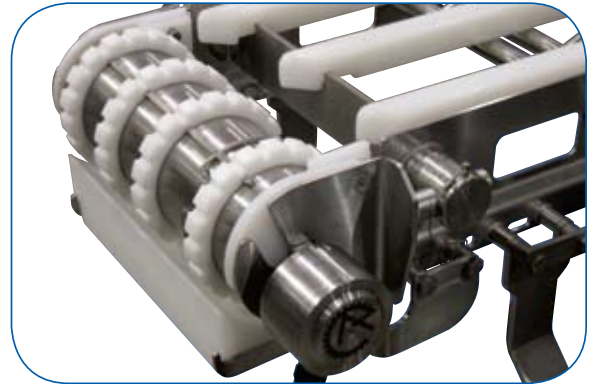

# ENGINEERED APPLICATIONS

## LANE & ADJUSTABLE GUIDING

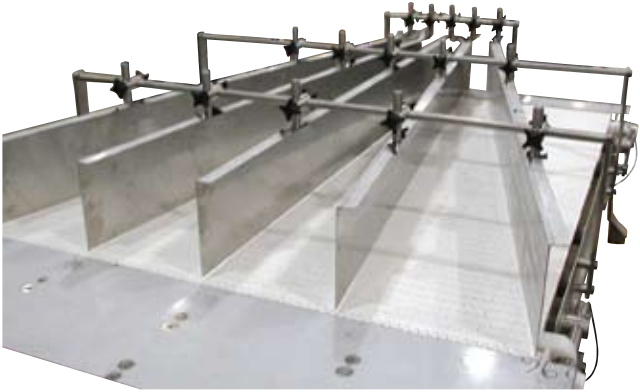

Controls product flow and direction, also adjustable for various-sized products.

- Accumulates large quantity of product
- Diverts product across lanes
- Merges multiple lanes to a single lane
- Support unstable product
- Stainless steel options available

## HOPPERS

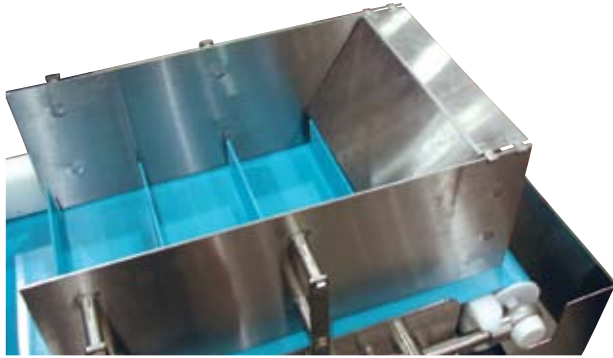

Guide product onto the conveyor and reduce product waste during quick-filling of conveyors.

- Locate and guide product onto conveyors
- Removable for easier maintenance and sanitation
- Stainless steel construction

## CHUTES



Steel, stainless and plastic chutes help guide product onto or away from the conveyor belt.

## CONVEYOR COVERS



Clear Lexan® or stainless steel covers can help improve operator safety and/or protect product from contamination.

## CEILING MOUNTED CONVEYORS

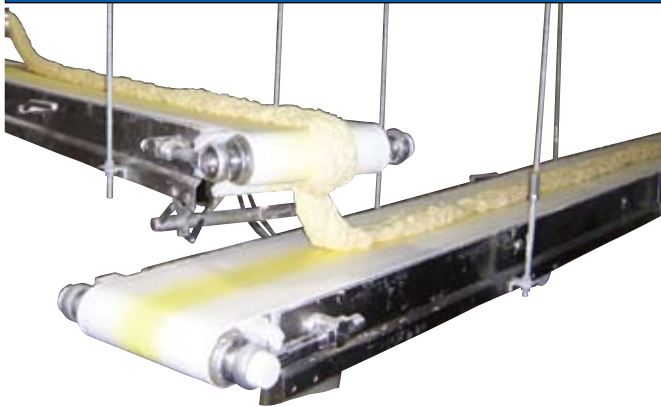

Save floor space by mounting conveyors from the ceiling.

## SCRAPER



Removes product build-up and releases product from belt.

- Adjustable tension accommodates a variety of products
- Stainless steel construction

## CLEAN IN PLACE

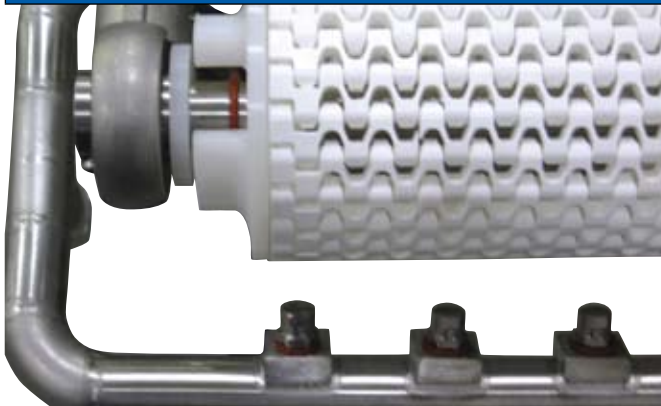

Reduce sanitation time and water usage with a Clean in Place unit.

- Automated washing system for modular belts
- Cleans the top and bottom surfaces of the belts
- Forces water through the open hinge of the belt

## MULTI-BELT CURVE



Create a tighter turn radius and reduce the amount of space required for a modular belt curve by using multiple belts on one conveyor frame.



# ENGINEERED APPLICATIONS

## DRIP PANS



Control product spillage and reduce cleaning time with drip pans.

- Collection for liquids and debris which fall from the product
- Can be hinged for easy clean-out or funneled to collect the liquid to a central location
- Drain option for easier cleaning
- All stainless steel construction

## WIRE BELT CONVEYORS



- Maximum air flow around products to heat or cool
- Variety of chain options for various application needs
- Minimum surface area reduces sanitation and cleaning time

## FRAME INTEGRATED CONVEYOR SIDE TABLES



One-piece design improves sanitation and facilitates additional assembly operations on the conveyor.

- Stainless steel operator side tables can be formed from the side of the conveyor
- Up to 10" (254 mm) wide
- Located on one or both sides of the conveyor

## DIVERTERS AND GATES



- Changes product direction to single or multiple locations.
- Often used to meter flow to specific areas or to separate products based on certain attributes.
- Control via proximity switches, photo eyes, counters and PLCs.
- Motion can be achieved via pneumatic or electric components.
- Available in a variety of materials.



From metal stamping to automated assembly, to food processing to packaging, we have the right conveyor for your application.



## 2200/2300 SERIES LOW PROFILE BELT CONVEYORS

Aluminum Extruded Construction

- Belt and modular belt options
- High performance conveying
- Streamlined machine interface
- Small parts transfers
- Efficient use of space
- Accumulation
- High temperatures
- Sharp parts
- Aesthetics
- iDrive 



## 3200 SERIES HEAVY DUTY BELT CONVEYORS

Aluminum Extruded Construction

- Straight, inclined and elevating configurations
- High performance conveying
- Main line, long lengths
- Heavy duty applications
- Fast belt speeds
- Aesthetics
- iDrive 



## 5200/5300 SERIES HEAVY DUTY CHAIN

Aluminum Extruded Construction

- Straight, curve, incline and decline configurations
- High performance conveying
- Main line, long lengths
- Heavy duty applications
- Fast belt speeds
- Part accumulation
- Automated and manual assembly



## 6200 SERIES LOW PROFILE BELT CONVEYORS

Stainless Steel Construction

- Tight space
- Basic conveying needs
- Wedge-Lok™ system
- Metal stamping
- Rugged environment
- Part accumulation
- Small part transfer

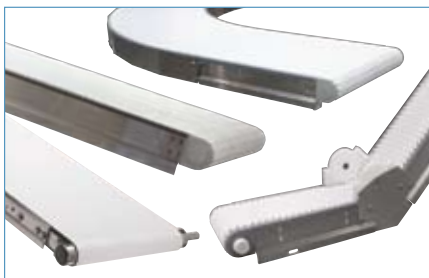

## AQUAGARD® FAMILY OF SANITARY CONVEYORS

Stainless Steel Construction; 7200, 7300, 7350, and 7360

- Straight, curve, incline and decline configurations
- Belt and modular belt options
- Industry leading speeds
- Small parts transfers
- Easy to accessorize - No drilling required
- 10 guiding packages available



## AQUAPRUF® FAMILY OF SANITARY CONVEYORS

Stainless Steel Construction; 7400, 7600 and Ultimate Series

- Straight, curve, incline and decline configurations
- Belt and modular belt options
- Wash-down and sanitary environments
- Clean rooms
- Chemical Resistance
- USDA, FDA, BISSC

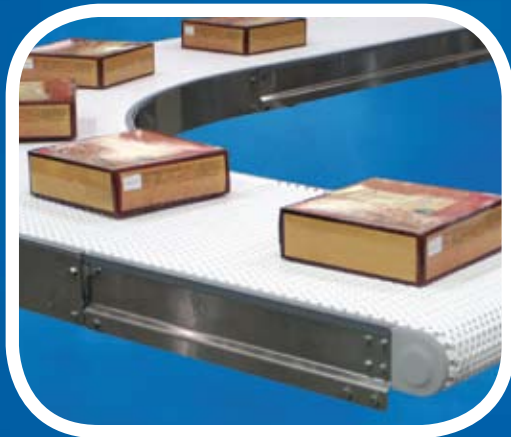
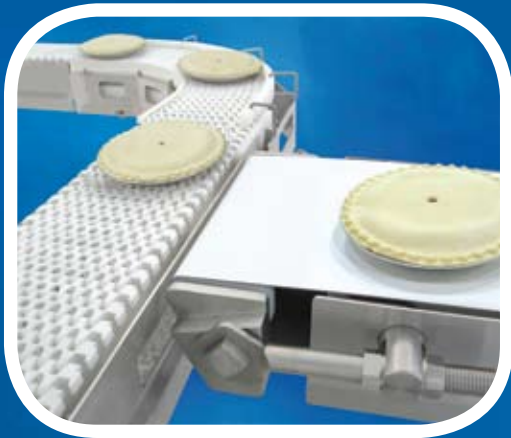

**[www.dorner.com](http://www.dorner.com) • [info@dorner.com](mailto:info@dorner.com)**

**DORNER MFG. CORP.**  
PO Box 20 • 975 Cottonwood Ave  
Hartland, WI 53029 USA

**INSIDE THE USA**  
TEL: 800.397.8664  
FAX: 800.369.2440

**OUTSIDE THE USA**  
TEL: 262.367.7600  
FAX: 262.367.5827

Dorner Mfg. Corp. reserves the right to change or discontinue products and specifications with or without notice.  
All products and services are covered in accordance with our standard warranty.  
© Dorner Mfg. Corp. 2010. All Rights Reserved. **851-598 Rev. G** Printed in the U.S.A. 3M-RYL-1210