

Complex Configurations
& Tight Spaces

High Speed Performance
-Up to 250 fpm

Industry-Best
Product Transfers

Specialty Solutions
& Pallet Systems



SMARTFLEX[®]

High-Performance, Flexible, Modular
Chain Conveyors

2200 SERIES

DORNER[®]
MOVE FAST. MOVE SMART.

SmartFlex® Conveyors are best for:

- Part Handling
- Transfers
- Tight Spaces
- Elevation Changes
- Accumulation
- Buffering
- Complex Configurations
- Long Lengths
- Curves, Jogs, Incline, Decline

Sizes & Measurements

- 65 mm / 85 mm / 105 mm / 150 mm / 180 mm (widths)
- 2' to 98' (lengths)

Loads & Speeds

- Up to 600 lbs
- Up to 250 fpm

Plastic Chain Types

- Standard: Low Friction & Friction Insert
- Specialty
 - Conductive
 - Cleated
 - Roller Top
 - Magnet Top

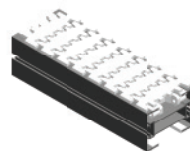

Flat

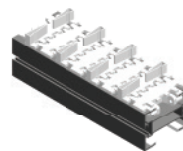

Cleated

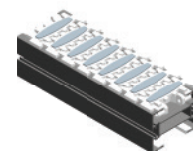

Friction Top

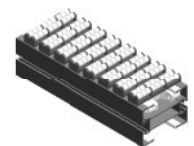

Roller Top

Modules



Drive



Idler



Curve
45°, 90°, 135°, 180°



Incline/Decline
5°, 10°, 20°, 30°

Transfers

- Industry-Best Transfers
- Multiple Mounting Options
- Powered or Roller

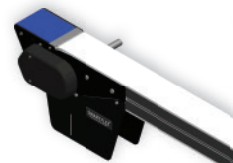

Outfeed / Infeed
Power Transfer



Infeed / Outfeed
Roller Transfer



Inline Belted
2200

Guiding



Adjustable Single Rail

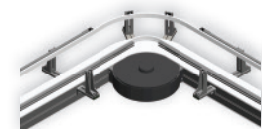

Adjustable Single Rail Curve

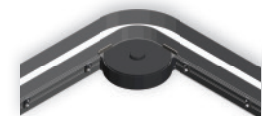

1" and 3" High Side

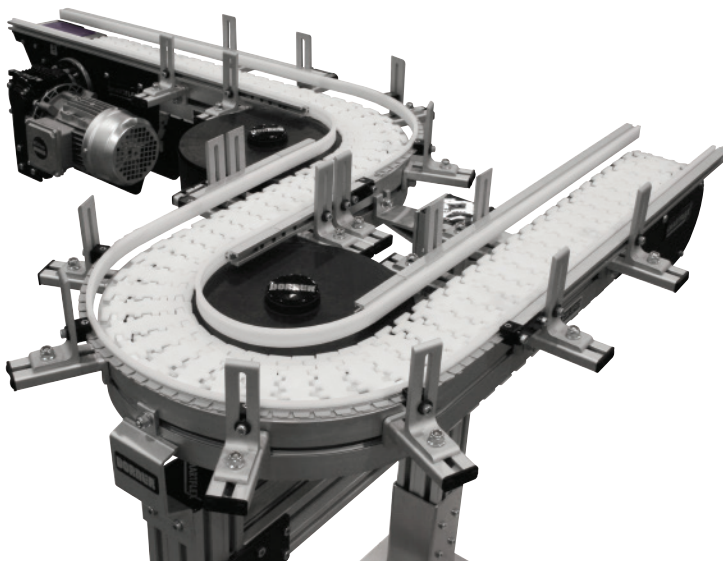

Common Drives



- Multiple conveyors can be coupled together and driven from a single gearmotor
- Conveyors move at same relative belt speed
- Creates single lanes for handling parts
- Wide parts or pallets can be carried by each conveyor to allow access from below
- Can be used on systems with curves

Alpines

- Ideal for inclines and declines in tight spaces
- Provides capability for vertical incline with minimal floor space
- Applications include accumulating, buffering, and cooling product between processes or machines
- Available in 65 mm, 85 mm, 105 mm, and 150 mm widths



Helical Curves & Spirals

- Reduces conveyor foot print saving valuable floor space
- Allows incline or decline through corners and straights
- Patent pending side roller chain reduces corner friction
- Provides capability for product buffering or storage for accumulation or cooling
- Provides capability for vertical incline with minimal floor space
- Simple, low cost Spiral for small parts handling
- Available in 85 mm and 180 mm belt width



Helical



Spiral

Wedge Elevators



- Specialty chain designed to securely convey a product by gripping the sides
- Saves footprint space by vertically lifting or lowering a product
- Available in 65 mm and 85 mm widths

Top Running Loops

- Continuous conveyor loop
- Mid drive module driving on single belt tooth (Includes belt hold down rollers)
- 30 ft max total conveyor length
- Compatible with standard load gearmotor
- Patent pending drive design
- Available in 65 mm, 85 mm, 105 mm, and 150 mm widths





SmartFlex Pallet Systems are Best for:

- Small to Medium Size Product Assembly
- Manual and Automated Assembly
- Product Testing and Inspection

Assembly Automation in:

- Automotive
- Life Science Products
- Electronics
- Health and Beauty Products
- Medical
- Appliance Products

Sizes & Measurements

- 105 mm (width)
- Available on SmartFlex or Top Running Loop SmartFlex Conveyors

Loads & Speeds

- Up to 600 lbs
- Up to 250 fpm

Merge & Diverts

- Multiple Kits styles available
 - Divert, Merge, and Merge and Divert
 - Multiple configurations including 45°, 90° and Parallel
- Pneumatic diverter. The gate arm location is below the Pin Tracking System, contacts the pallet base puck
- Pneumatic diverter position is adjustable in both positions
- Height of the divert arm is adjustable

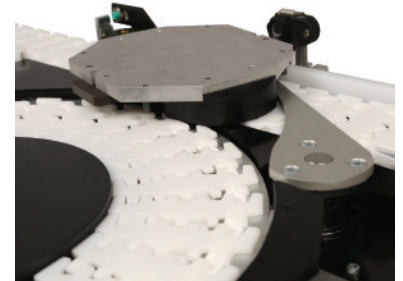

Diverts

Lift & Locate Station

- ± 0.004" accuracy
- 200 lbs holding force
- Includes 1 pallet stop (cushioned or non-cushioned, and sensor mounts)
- Max usable width = pallet width



Lift & Locate

Pallet Stops

- Available in Cushioned & Non-Cushioned Models
- Pneumatic Stop
- Capable of back to back pacing
- Up to 100 lbs total per pallet stop @ 100 fpm
- Lower speed increases load capacity



Non-Cushioned Pallet Stop

Pallets

- 190 mm wide
- 100 mm, 150 mm, and 200 mm lengths
- Max product load = 20 lbs
- Unique Pin Tracking System
 - Pins guide pallet along conveyor
 - Pallet guide only needed on outside of loop
 - Pins provide accuracy at stop location
- Pallets can be purchased as completed assemblies or as kits for custom fabricated top plates
- Bumper material available to reduce noise and vibration in accumulated pallets



Optional Bumper

Pin



Industry Best Product Transfers

- Powered transfers allow for smooth end transfers for products as small as 3" in diameter. They are slave driven off of the conveyor and can be attached to the infeed or exit.

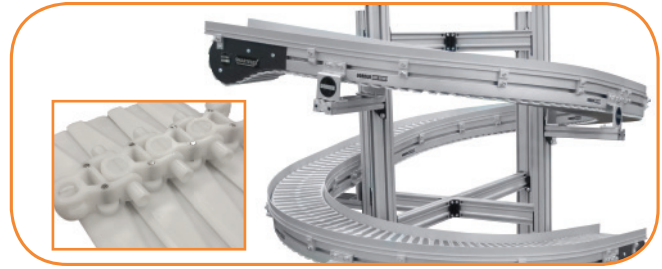

Helical Curve & Spiral Chain

- Patent pending side roller chain reduces corner friction allowing for multiple turns while maintaining loads and speeds.

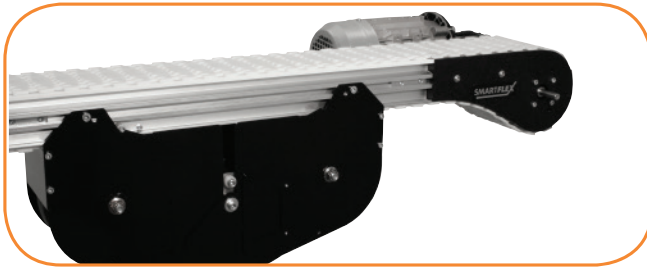

Weighted Take-up Module

- The unique, compact weighted take up is designed to prevent catenary sag and eliminate potential pinch points for safety.

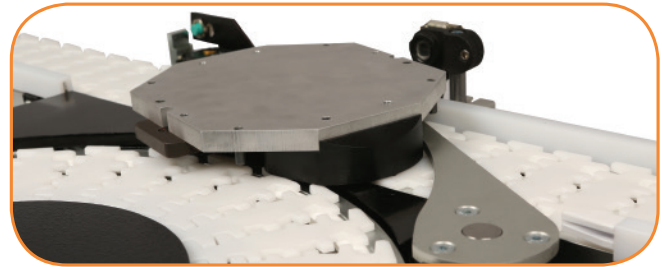

Pallet Handling with Pin Tracking

- SmartFlex Pallet Systems feature a unique pin tracking system to guide the pallet along and provide accuracy at stop locations.

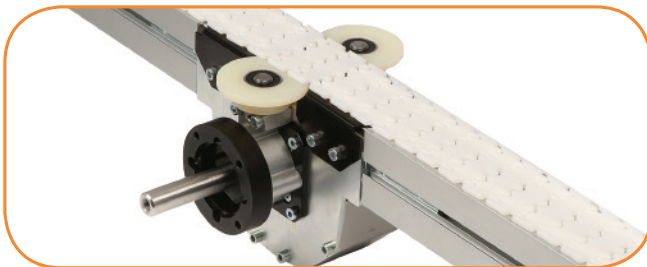

Top Running Loop Drive Design

- The continuous loop features a patent pending top running drive design for added strength, flexibility, and load capabilities.



Online Configurator

- Engineer simple or complex conveyors to meet your needs in minutes. The industry leading tool delivers a complete 3D CAD assembly model for instant validation of fit.

The Benefits of a Dorner 2200 Series SmartFlex® Conveyor

Reduces Costs

- Delivered pre-assembled to your exact specifications; saving labor costs
- Reduces commissioning time
- Eliminates unnecessary cutting, inventory and waste
- Industry leading product transfers eliminate costly product jams, bottlenecks, and damage

Saves Time

- Dorner's online configurator engineers simple or complex conveyors to meet your needs in minutes
- The industry leading tool delivers a complete 3D CAD assembly model for instant validation of fit

Delivers Fast

- Dorner sets the industry standard for delivery
- SmartFlex® is shattering the norm with conveyors available to ship in 5 working days and complete Pallet Systems shipping in 20 days

At Dorner we make it our mission to provide you with a system that you can depend on to move your product from point A to point B with precision and speed. It's that commitment and history of proven excellence that has made the Dorner Brand a recognized leader in precision conveyors for nearly 50 years. With our complete line of customizable conveyor systems we have the perfect solution for you!



1X Series

The 1X Series Line is designed for small part handling and transfers where space is a premium.

1X Series Family:

- Flat Belt
- Aluminum Frame
- Widths to 10"
- Loads to 15 lbs
- Speeds up to 80 fpm



2X Series

The 2X Series Line is engineered for small to medium sized parts, precision applications and flexible layouts.

2X Series Family:

- Flat Belt
- Cleated Belt
- Modular Belt
- Precision Move
- SmartFlex®
- Aluminum Frame
- Widths to 24"
- Loads to 200 lbs
- Speeds up to 400 fpm
- Curves



3X Series

The 3X Series Line is designed for medium to heavy sized parts, precision applications, bulk handling and flexible layouts.

3X Series Family:

- Flat Belt
- Cleated Belt
- Modular Belt
- Flexible Chain
- Precision Move
- Aluminum Frame
- Widths to 60"
- Loads to 1000 lbs
- Speeds up to 600 fpm
- Curves
- Z-Frame Elevators

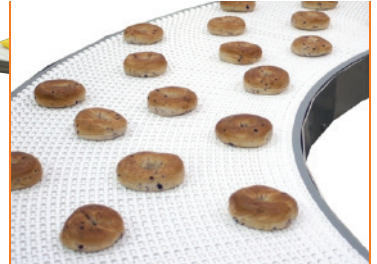

7X Series

The 7X Series Stainless Steel Line is engineered for small to heavy product requiring various levels of sanitary design and flexible layouts.

7X Series Family:

- AquaPruf® + AquaGuard®
- Flat Belt
- Cleated Belt
- Modular Belt
- Flexible Chain
- Vertical Belt Technology
- Stainless Steel Frame
- Widths to 52"
- Loads to 750 lbs
- Speeds up to 400 fpm
- Curves
- Z-Frame Elevators

NEED SOMETHING DIFFERENT?

DORNER'S **ENGINEERED SOLUTIONS GROUP** PROVIDES EXACTLY WHAT YOU NEED FOR YOUR SPECIFIC APPLICATION. FROM MODIFIED STANDARD CONVEYORS TO COMPLETE CUSTOM DESIGNS.

LOOKING FOR AFTER SALE SUPPORT?

DORNER'S **SERVICES TEAM** PROVIDES COMPLETE SUPPORT FROM REPLACEMENT PARTS TO INSTALLATION AND MAINTENANCE SERVICES.



DORNER MFG. CORP.
PO Box 20 • 975 Cottonwood Ave.
Hartland, WI 53029 USA

INSIDE THE USA
TEL: 800.397.8664
FAX: 800.369.2440

OUTSIDE THE USA
TEL: 262.367.7600
FAX: 262.367.5827

www.dorner.com
info@dorner.com

